



مؤسسة الفجر  
al fajer establishment

A MEMBER OF AL FAJER GROUP 42 years

[www.fajerest.com](http://www.fajerest.com)

# CORPORATE PROFILE 2015



ESTABLISHING FOR THE FUTURE

Enter 



مؤسسة الفجر  
al fajer establishment

A MEMBER OF AL FAJER GROUP

Welcome



*Al Fajer Establishment Group of Companies has been in industry more than 40 years founded in 1973. Al Fajer Group based in Dubai, United Arab Emirates owned by **H. H. Sheikh Hasher Maktoum Juma Al Maktoum.***

*Today Al Fajer Group operates in the UAE and GCC markets as well. The highly qualified, experienced and professional multi-national team players, with the thousands of employees. It's highly successful businesses are engaged in Building material, Security Solution, Electric golf carts, Decorative paint collections, Surveying products, Home Automation, Trading and Distribution Services.*

*Al Fajer Establishment's Having built an unparalleled infrastructure for storage, sales and distribution backed by prompt after sales service, Al Fajer Establishment, today is one of the most leading professional trading organization for quality and services in UAE.*

*Al Fajer Establishment is also proud to announce its overseas operations with the opening of its new office and showroom in the State of Qatar.*

# COMPANY

## DIVISIONS



مؤسسة الفجر  
al fajer establishment

A MEMBER OF AL FAJER GROUP

[www.fajerest.com](http://www.fajerest.com)



**Building Materials division** is one of the leading building materials distributor in Gulf. A general trading company with almost 4 decades of expertise representing world renowned and Leading Brand of products catering to the Construction & Consumer Section. Our Building Materials division has the sole distributorship of selected recognized branded products from different parts of the world.

Over the years Building Materials Division has developed an excellent sourcing network all over the world especially in U.A.E for identifying quality products and for application to suit the ever changing consumer demands in the United Arab Emirates. Having built an unparallel infrastructure for storage, sales and distribution backed by highly well trained staff.





www.rbaferro.com

## Man Hole Covers

### Our Theme:

Best Quality Distribution

### Our Goal:

Quality Brand, Perfection & Continued Improvement in our series of products & world-wide distribution.

### Salient Features:

Available in Different Sizes & shapes

Man Hole Covers are available in Cast & Ductile Iron

Features an excellent strength to weight ratio for super strong gratings and frames

Provides high resistance to traffic stresses and maintenance operations (e.g.: road repair, snow plowing, chamber cleaning, etc.)

### Quality Assurance:

The RBA grating and frame has been designed manufactured within a Certified ISO 9000-2000 quality management system, certified by an independently and internationally recognized company



مؤسسة الفجر  
al fajer establishment

A MEMBER OF AL FAJER GROUP

www.fajerest.com

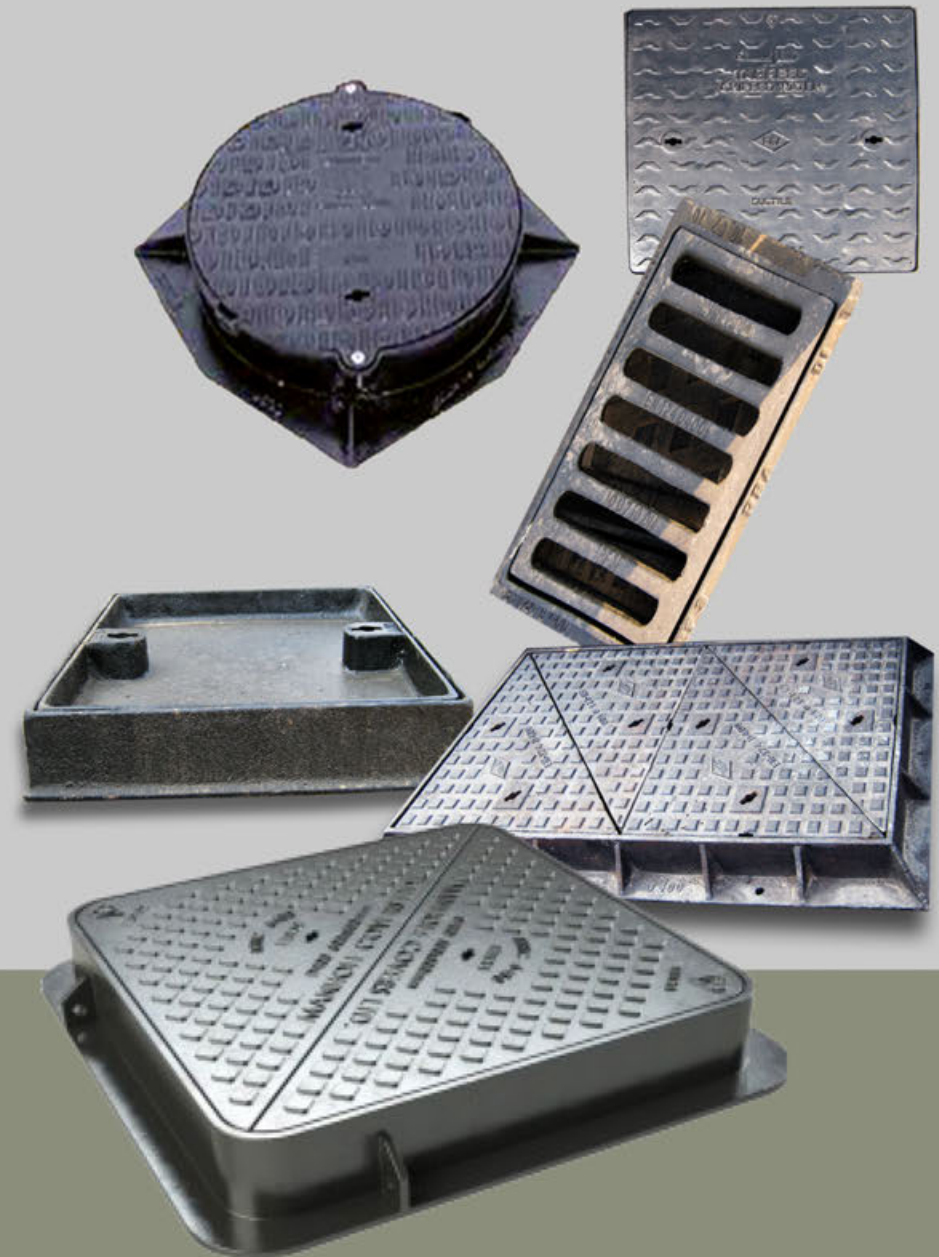

Sixty years dedicated to maintaining traditions in the brick and tile industry, giving it an important role to play as a point of reference for the future too.

This is industry Pica, a dynamic group and a model of manufacturing organisation where, every day professionals and technologies work towards an important objective: quality and customer service.

And this lies behind the numerous activities taking place in the 3 factories and 6 production plants owned by industrie pica and located throughout Italy.



**Clay Roof Tiles, Natural and Antique Finished with Complete Accessories**



### Terracotta Flooring and Accessories

Range, quality and technology. PICA roof tiles: modern and practical solutions with their roots deep in the past. A range so complete that you can choose the best possible solution from fourteen different tiles and three types of concave tile: a host of product proposals for a host of different living solutions.

Not only that, but the range also includes various special pieces and ridge tiles with different finishes to provide the definitive answer to every roof covering need. Experience, carefully selected raw materials and cutting-edge technology make PICA roof tiles the product when it comes to meeting living requirements of the highest level.

Another leading brand by Imerys Toiture-Creamica Collado hails from the Spanish region of Almansa, a land of arid landscape that produces some of the finest Spanish wines, is the source of richness and character behind the spirit of creativeness at Collado. White and red clays, like their wines, combined with a unique savoir-faire have led to a range of colours that reflects the beauty of Spanish tradition.

*Almansa Clay Roof Tiles, Natural and Antique Finished with Complete Accessories*



**ROOF TILES**  **COBERT**  
uralita

Cobert Roof Tiles belongs to the Spanish multiannual Uralita Group, a construction materials company with more than 100 years history. Nowadays, Uralita Group has 40 production centres spread all over Europe, where the company produces materials for roofs, pipes interior partition walls, gypsum and insulation.

Cobert Roof Tiles, leader and first manufacturer in Spain and Portugal, has 9 factories with a powerful industrial and commercial infrastructure in order to satisfy our customer's quality, design, service and distribution requirement.





Ceipo Ceramiche has been in business for over 40 years, specialized in the production of roof tiles and varnished sunbreaks.

We produce varnished singlecooked roof tiles in 220 colors, which are available in both single colored forms or in what we call "smoked" versions, where one color is mixed with another. Furthermore, our company is able to offer various types of varnish on request and tailor made for the client.

Since 1949 Ceipo Ceramiche products are the best match between:

- Tuscan clay
- The superior quality of Italian design
- High and advanced technology
- Creativity
- Strength of a well-established.

Use our product and leave a lasting mark in time, a unique and attractive style that meets the imagination of professionals and individuals.

Ceipo Ceramics distributes its production worldwide.

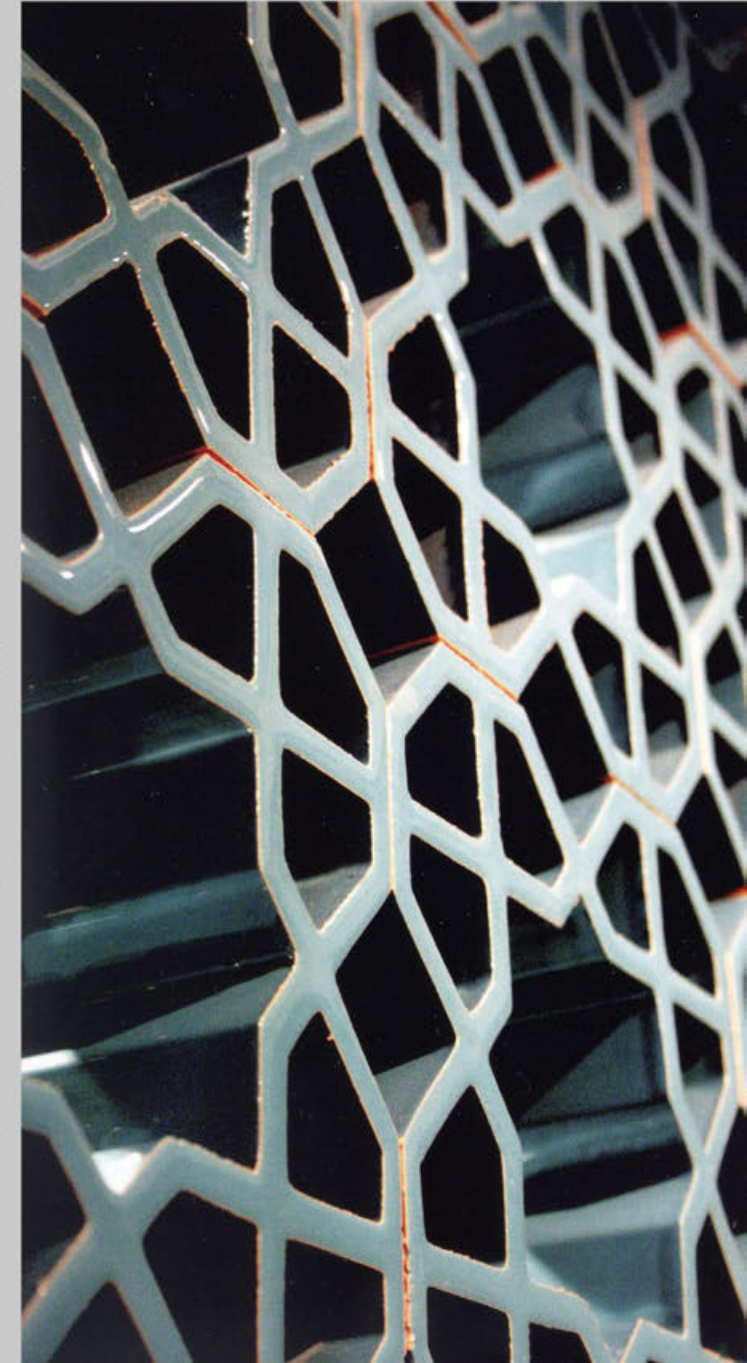
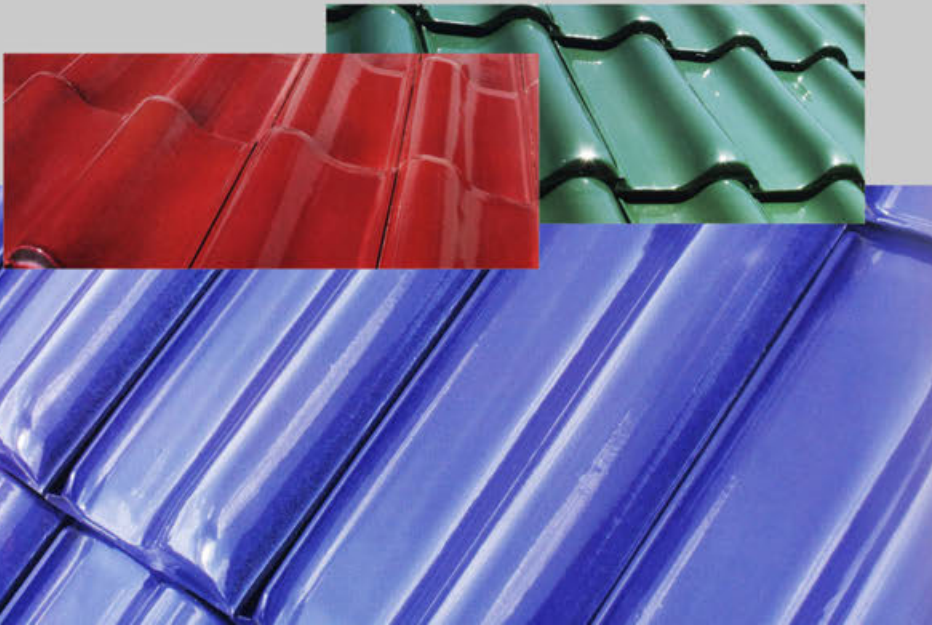



www.gresmanc.com



مؤسسة الفجر  
al fajer establishment

A MEMBER OF AL FAJER GROUP

www.fajerest.com

GRES DE LA MANCHA is a branch of the group of companies Pastrana, devoted to the manufacturing of high quality extruded tiles-Klinker. Gres de La Mancha counts with two different manufacturing plants: GRESMANC AND DULCINEA.

The installations are equipped with the state of the art production technologies, and with the latest machinery, allowing us to obtain a high quality product, being this the base of our growth strategy and diversification in the most demanding markets both national and foreign.

Our I+D+i department is continuously developing new products and applications to achieve a leading role in design and innovation.

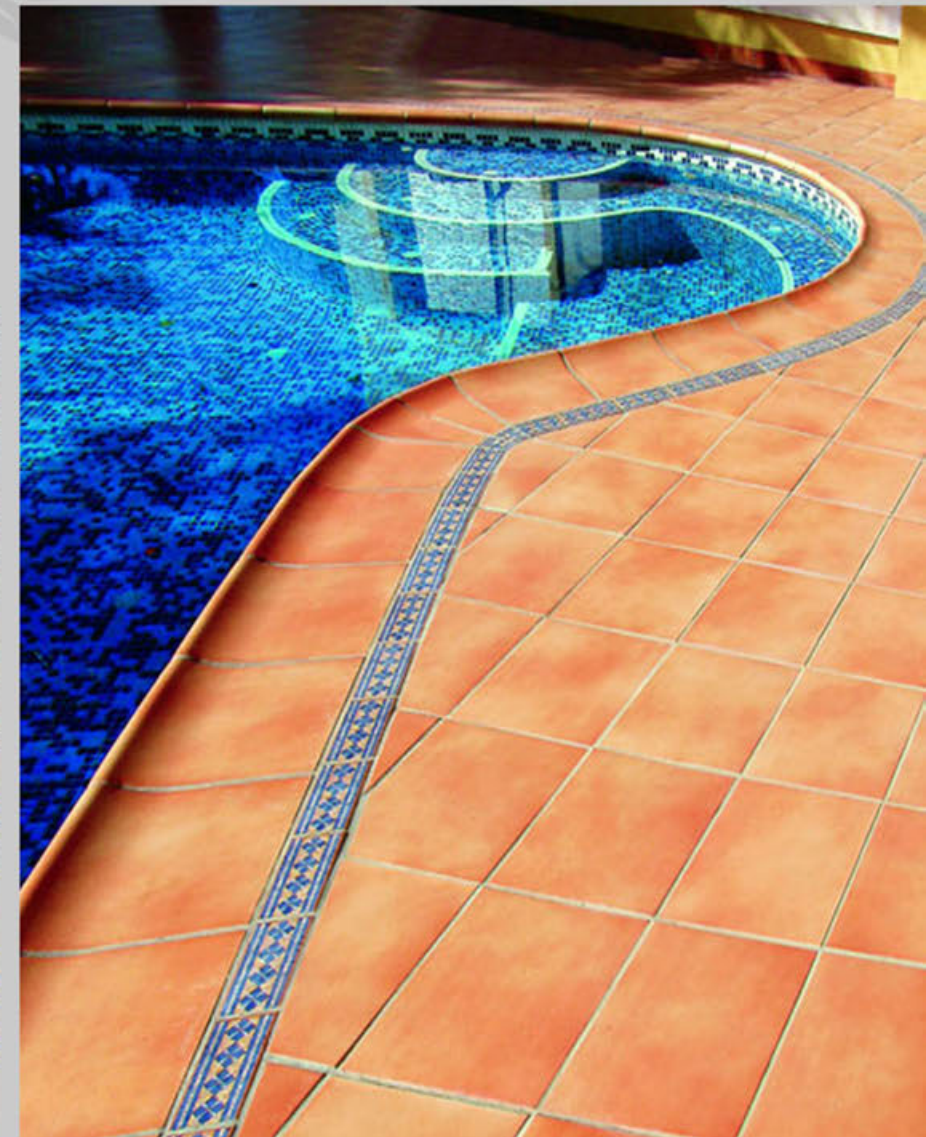

Terra cotta Floor Tiles, for walls, flooring, stair, and Interior or Exterior design

**“SCC is one of the most well-known and well-established local brands.”**

Saudi Ceramic Company is a leading manufacturer and marketer of ceramic tiles, sanitary ware and electrical water heaters.

It was founded in 1977 by a group of prominent Saudi businessmen with the support and coordination of few local financial institutions.

Headquartered in Riyadh, the company has achieved a reputation for high standards and quality production.

With the presence of more than 32 years in the local market, SCC is considered one of the most well-established local brands.

Prompt customer service and satisfaction are the trademark of SCC as part of its long-term visionary approach.

With a distinguished leadership in Arab countries, the company has also been exporting extensively to foreign markets and its products are now available in various.



**BALDOCER**  
CERAMICAS

[www.baldocer.com](http://www.baldocer.com)

## TRENDS THAT STAND OUT FROM THE REST

Our style and quality, our determination to offer the most vanguard personal product, turns Baldocer into one of the companies with the highest renown and prestige of the current panorama.

Since 1994 until today, we have been working for the innovation and development of ceramic technology in order to tackle the last esthetic and technical trends.

At the same time, recovering and preserving traditional styles have been a part of our identity as a company.



مؤسسة الفجر  
al fajer establishment

A MEMBER OF AL FAJER GROUP

[www.fajerest.com](http://www.fajerest.com)

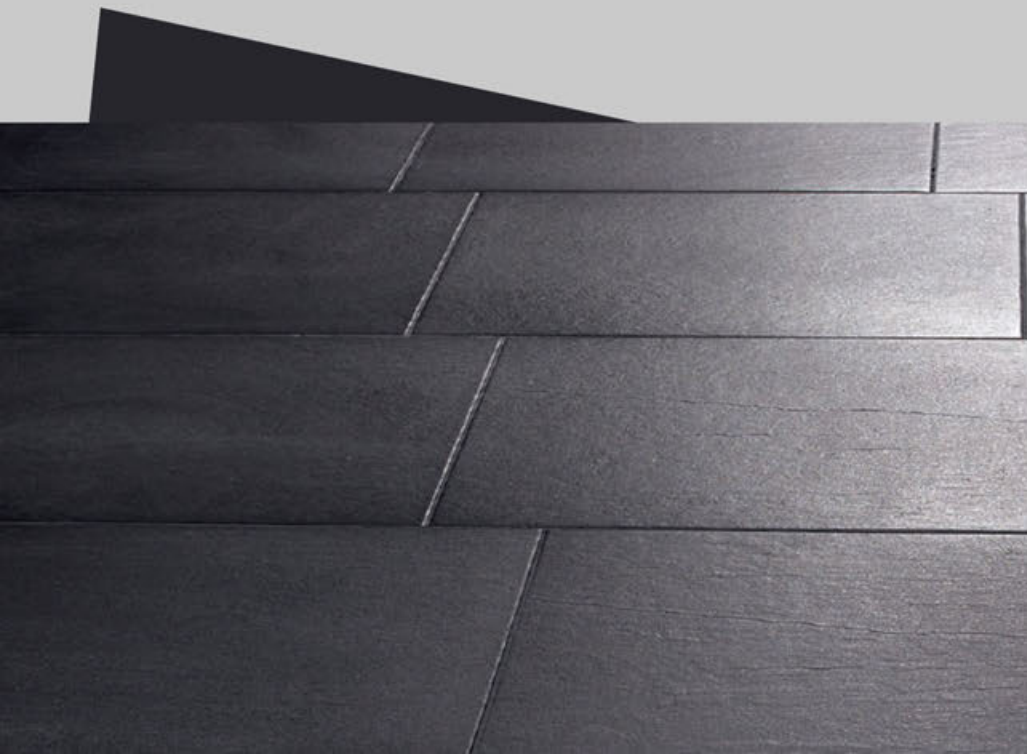

We are one of the foremost players in the global tile arena in offering high quality porcelain and ceramic tiles with concept and style. Our vision is to meet the ever demanding needs of the architectural fraternity and the aspirations of every consumer, through cost-effective, innovative and creative products.

We reach out to most parts of the globe in offering products of variety suitable to different lifestyles.

From its foundation in 1963, Undefa has been kept always faithful to a few principles. The creative passion in the design, the attention brightened to the client, the efficiency in the treatment with suppliers and the permanent effort for the quality they are the keys that they describe the model of Undefa 's business.



EXAGRES long trajectory extruded ceramic manufacturer, dedicates a specific product line for swimming pools. EXAGRES certificated ISO 9001 all along the process: I+D, Production, Distribution, Technical Advice an After-Sales, it provides high developed products to architects, constructors, public and private promoter disposition with a high quality level material.

EXAGRES shows 5 differents pool-edge systems, public, private and sport swimming-pool

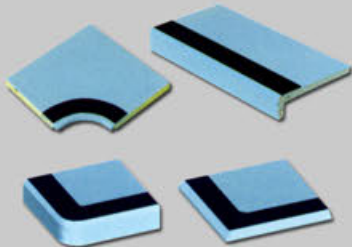

Founded in 1867 by Charles Haemmerlin, society Haemmerlin celebrates this year its 140th anniversary in 2007.

Haemmerlin is an industrial and human adventure that began in a metal workshop and continues today on three industrial sites (France / United Kingdom / Italy).

The family business has evolved over its life an international group employing 300 people and assets in 50 pays.

140 years is the result of a journey and a great story made possible by the quality of products Haemmerlin, but especially by the work of his homes.

Pas birthday without a gift: the company offered a wheelbarrow "Pen Limited Edition 140" on each employee, and key partners, and a pink especially created for the 140 years of Group.

A wheelbarrow "Plume 140 years the colors of the TGV Est EUROPEENL a wheelbarrow Plume 140 years" Inte



**centaure**<sup>®</sup>

[www.centaure.fr](http://www.centaure.fr)



مؤسسة الفجر  
al fajer establishment

A MEMBER OF AL FAJER GROUP

[www.fajerest.com](http://www.fajerest.com)

Centaure - this means

- Two industrial sites including automatised and semi-automatised production lines.
- An innovating Research and Development Department as far as ergonomics, comfort and safety are concerned.
- Quality Department who interferes at each stage of manufacturing, from the reception of raw materials to the marketing.
- A Marketing and Sales Department, France and Export, structured to listen to you and react immediately. And above all, Centaure is a reference trademark in the field of the aluminum access material.





Alusel Company manufactures highest quality aluminum and steel slats for rolling shutters and rolling doors systems. Automatic garage doors rolling shutters grilles gate parking barriers, remote controlled roller shutters for doors, windows & garages.

Excellent features of rolling shutters in every season and every climate can be summarized

as follows:

- Sun protection
- Weather protection (rain, wind, sand storm),
- Noise protection
- Screening from view and providing privacy to the people living in this building
- Excellent acoustic and thermal insulation characteristics provided by high quality special polyurethane.
- Protection against break-in (intruders)
- Heat protection from the outside to the inside of the building
- Heat and cold insulation from the inside to the outside of the building
- Regulation of light conditions inside the building
- Protection against insects, with some options.
- Decoration of the building with a big variety of matching colors.



C.H.I. Overhead Doors is a prominent garage door company and a manufacturer of residential sectional garage doors, as well as commercial sectional and rolling steel. C.H.I. produces the highest quality garage doors by integrating premium-quality materials with superior designs and workmanship while maintaining a strong focus on end user satisfaction. Dedicated to providing top quality overhead doors, backed by the best customer service and dealer support in the industry, it becomes clear why C.H.I. is

### "The Door To Quality"

- Door exterior sections are formed 26-gauge galvanized draw quality steel and the interior is 27-gauge
- High-density polyurethane injected core
- Long-lasting durable rollers assure consistence, efficient operation
- Heavy-duty 14-gauge hinges with "wide body" pattern for greater stability and longer life
- Extra heavy paint system in your choice of white, almond, sandstone, brown, bronze, or evergreen
- Concealed steel plates run continuously from top to bottom of each section for fastening hardware
- Optional Endurance and Appearance Package upgrades available
- White painted end stiles
- Thermally-broken for optimum weather protection
- Bottom weather seal utilizes an aluminum retainer and extruded virgin vinyl
- A continuous weather seal at the section joint assures maximum protection from the elements

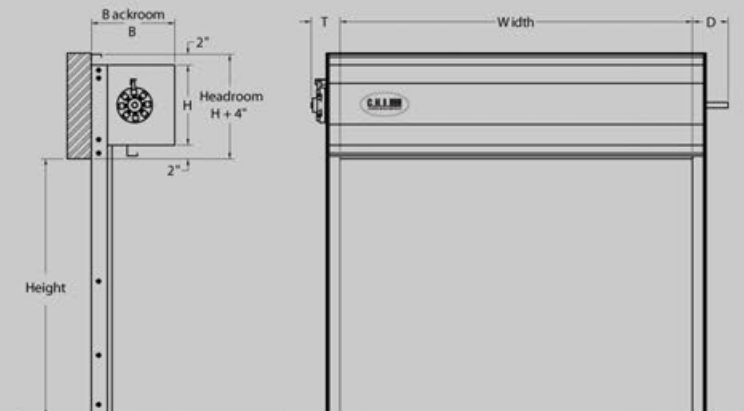

Tejas Cobert is the leading reference in the Iberian Peninsula for manufacturing and commercializing clay and concrete roof tiles, accessories and components for roofs. Roof tile business started in seventies with production of concrete roof tiles and it was complemented from 1985 with production of clay tile and cooperation agreements with British manufacturer Redland.

After acquisition of Céramica Collado and its maximal quality clay tiles, Cobert Roof tiles is consolidated as a reference in its sector.

Every year Tejas Cobert has been increasing its presence on rooftops, not only of the Iberian Peninsula, but also on the roofs of the other countries of the five continents.

Cobert currently produces and sells ceramic tiles, concrete tiles, accessories and roofing components, developing their production activity in seven factories in Spain and Portugal.

## 100 years of history

Cobert Roof Tiles belongs to the Spanish multinational Uralita Group, a construction materials company with more than 100 years of history.

Cobert Roof Tiles, leader and first manufacturer in Spain and Portugal, has 8 factories with a powerful industrial and commercial infrastructure.



Cobert Roof Tiles  
the importance of choosing well



## clay roof tiles and roof accessories

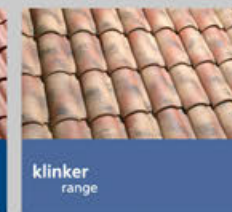

IBL spa was founded in 1964 with the "Industria Bolognese Laterizi" plant in Bentivoglio (BO) and Later expanded with the acquisition of a furnace located in Cotignola (RA) and the Ceprano roofing tiles plant.

IBL spa was then acquired in 1996 by the DAFIN Group, a financial company owned by the D'Agostino family, that has been operating for decades in the construction market, with companies such as La Fabbrica spa.

The technologically advanced production plants of Bentivoglio and Cotignola are specialized in the production of common bricks, extruded facing bricks (Bentivoglio) and soft mud facing bricks (Cotignola).

Since 2009, with the acquisition of the Ceprano roofing tiles plant, - one of the most important plant in Italy for the production of terracotta roof tiles, special pieces and accessories for roof coverings - IBL has been able to supply a full range of construction products, providing solutions for any architectural need.

"Producing well to build better" this is the philosophy that has accompanied our development and success over the years.



LATERIZI DA INTONACO  
COMMON BRICKS



LATERIZI IN PASTA MOLLE  
SOFT MUD BRICKS



COPERTURE  
ROOF TILES



**HUNTINGTON BRASS**

*A splash of elegance*

[www.huntingtonbrass.com](http://www.huntingtonbrass.com)



مؤسسة الفجر  
**al fajer establishment**

A MEMBER OF AL FAJER GROUP

[www.fajerest.com](http://www.fajerest.com)

We are committed to provide value added products that are manufactured with outstanding quality while providing consistency in servicing our customers with excellence.

We promote and conduct business with ethical business practices and professionalism, and we strive to provide our associates with a safe, professional, and friendly working environment.

Huntington Brass is a well known brand in USA, founded in 1989, both importing and manufacturing ceramic ware, faucets, handles, shower parts, and plumbing components from Asia and Europe including its own manufacturing plants in China and Taiwan. Huntington Brass offers two ranges of products: the Professional Collection and the Platinum Collection.

The Professional Collection features a basic line of products, with a simple, modest appearance that are reasonably priced. The Platinum Collection features high-end products which exhibit a correspondingly high level of design and finish, and a larger range of applications.

The company is committed to total quality in products and service, as evidenced by its recent ISO 9001:2000 certification.



We offer design solutions with installation and maintenance for cabinets for your kitchen. Our network of kitchen cabinet professionals can help you with your design, door style and colour selection. No matter what the scope of your project, you can have a vibrant and inviting new kitchen that functions the way you want it to.

Choose from many different features and finishes that work best for you and will help you enjoy the way you live. We work with you to get the ideal kitchen and stay within your budget. Each of our Kitchen Styles has its own distinctive flair, whether it's traditional or contemporary design.

They all have certain features that you will like. There are so many great kitchen cabinet styles to choose from. Select a style that works with one of your kitchen decorating themes and blends well with the rest of your home



# Landscaping

www.fajerest.com

Choosing the right landscaping and garden design products can bring your garden or outdoor space alive. make a practical and useful area for your family, create a relaxing haven or even space for dining.

If you're talking retaining walls or paving stones, functionality and good looks have to blend together. along with that, you want these landscaping products.

## Following Products:

### Wall cladding & Floor Finishing

- Sandstones
- Limestone
- Slate
- Granite

### Natural & Polished Finished

- Pebbles Stone

### Cobbles & Cubes

- Sandstone
- Granite

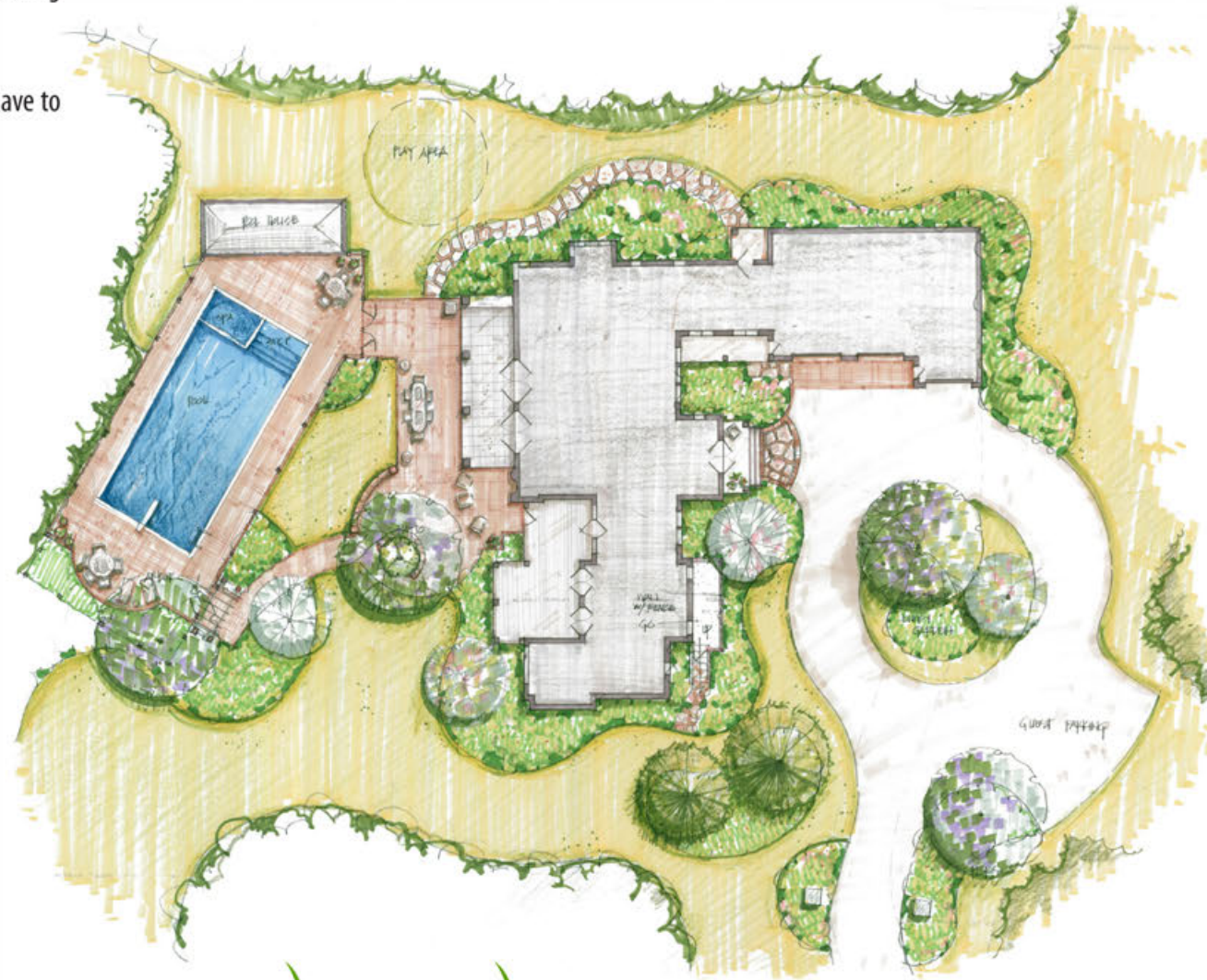

GAMINETTI  
**CLAM**

Barbeque cooking outdoors has become more of a regular activity

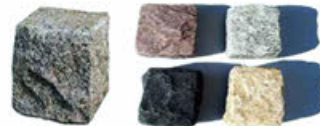

## OTHER PRODUCTS

### Glass Blocks

Glass blocks are suitable for both commercial and residential purposes and can be used to fill window openings, form dividing walls, external walls, in the creation of shower cubicles, bars, terraces, and desks.

In fact the design potential for the use of glass blocks in any construction is limited only by your imagination.

Bring new dimension design to your home or office with graceful glass curves, artful angles, colors and beautiful patterns.

The Glass Block up System offers a process that takes you from start to finish in no time. This system allows customers the ability to save time, money and labor using our easy metal frame or frame less system.



### Flexcell Sheet

Jolly Bitulex is presented by Jolly Board Ltd.; pioneers of soft board manufacture in Asia. Jolly Board has been manufacturing Jolly Bitulex and exporting quality bitumen impregnated expansion joint fillers for the past 40 years.

#### Characteristics:

- Jolly Bitulex is processed from cane fiber and bitumen. These raw materials are tested and proven to provide the best resilience.
- Jolly Bitulex is available in a wide range of thicknesses and sizes.
- Jolly Bitulex is an environment friendly product as opposed to the environment destroying thermocole / plastic expansion joint fillers.
- The Board's compression and recovery characteristics conform to the American, European, British and Indian standards.

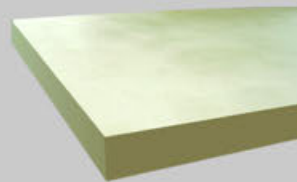

مؤسسة الفجر  
al fajer establishment

A MEMBER OF AL FAJER GROUP

[www.fajerest.com](http://www.fajerest.com)

### Fire Bricks

A fire brick is a block of refractory ceramic material. A refractory brick withstands high heat, and has low thermal conductivity to save energy. Fire bricks are usually used where there is exposure to significant chemical, thermal or mechanical stress, which would cause an ordinary brick or building material to break down.



### Indian Bricks

Our finishing Products have helped structural engineers to achieve a very pleasant, durable and maintenance free finish to building.





Al Fajer Establishment is proud to be the Sole Distributor of Topcon Precision Positioning Instruments in United Arab Emirates since 1985.

Topcon is known for its innovation and top-notch equipment. We offer a full line of survey instruments designed using our exclusive technologies. From the most advanced robotic total station to the most rugged waterproof & affordable levels, our priority is productivity. Topcon has also developed construction and agriculture equipment automation, integrated image processing and GPS technology. Topcon is now recognized around the globe as both a pioneer and leader in the precision positioning industry.

We have a full-fledged TOPCON authorized SERVICE CENTER located in Dubai (Airport Road) and also Qualified Service Engineers trained from TOPCON, JAPAN. We do servicing and calibrations of TOPCON instruments with industrial standards DIN 18723 (ISO 12857). We have branch in Abu Dhabi, with service center.

Our main dedicated survey instruments include, GPS/Glonass Receivers, Total stations (Robotic, Standard & reflectorless), Digital Theodolite, Laser Instruments (Pipe laser, Horizontal/Vertical) & Automatic Levels.

When it's time for simple solutions for complicated problems, there's one name that stands above the competition: Topcon.



Brands:



Ever since its establishment, Topcon has maintained optics technology as a core technology and has now merged this field with digital technology to develop a wide range of businesses. The company's optical technology, spanning a wide range of wavelengths from electron beams to infrared rays, is unusual within the industry for its breadth.

### **Surveying Instruments**

- Auto level
- Laser Level
- Digital Theodolite
- Electronic Total Station ( Basic & Advanced with Windows CE)
- Reflector less Total Station ( 2000 mts )
- Robotic Total Station
- Image Stations & Scanners
- Surveying Accessories

### **Positioning Instruments**

- GNSS (GPS + GLONASS Receiver for RTK, Static,)
- Millimeter GPS
- GIS

### **Survey Software Civil Cad**

- Unique & Powerful software for Surveying & civil Engineering Professionals
- Available in Different modules (From Instrument Interfacing to volume Calculation)





E-mail: hwt@fajerest.ae

The Hardware & Tools Division of Al Fajer Establishment become one of the distinct name in the field of hardware tools as serving UAE in Quality Hardware Tools.

We represent some of the world classy brands namely L.G.Harris & CO. LTD UK, Tough Built & Tactix.

HARRIS, in the field of decorating products, since 1928 L.G HARRIS & Co LTD has been associated with quality, performance & innovation. They recognized that a product was most likely to succeed if it was carefully designed to meet identified consumer needs. As they are the world class manufacturer of decorating products as Paint Brushes, Paint Rollers, Scrappers & Decorating tools.

TACTIX which is under Meridian International an ISO9001 accredited company has successfully established itself as one of the leading organizations serving the tools & hardware market. Having a huge range of products like tools for fastening, Automotive, Measuring, Cementing & Painting, Electrician etc. With intensive research for product development to meet the customer needs the tools are quite top notch quality.

TOUGH BUILT is specially designed tool bags, tool set, pouches to meet the daily demands of field work. Having a range of products including tool bags, hand tools, saw horse & pouches which is very easy to use & affordable. Made with high quality materials to meet the rigorous demands of the professionals & provide superior accessibility.



Brands: \_\_\_\_\_

**Harris**  
Inspiration Innovation Decoration

**TOUGHBUILT**

**TACTIX**



مؤسسة الفجر  
**al fajer establishment**

A MEMBER OF AL FAJER GROUP

www.fajerest.com

high quality  
**Hand Tools**  
with wide range



# Harris®

Inspiration Innovation Decoration

www.harrisbrushes.com

HARRIS have been manufacturing paint brushes, rollers and tools since 1928 and in that time they have made it their mission to create tools that make decorating easier, more efficient and enjoyable. The product is most likely to succeed if it is carefully designed to meet consumer needs and this is why HARRIS invest heavily in research, innovation and product development.

Our market leading design capabilities and unrivalled service have enabled both Harris and many of its customers to become market dominant with clear differentiation that consumers understand.

## Products Range

- Paint Brushes
- Paint Rollers
- Hand Tools
- Protection Tools

Down to Earth is a range of decorating products specially designed to be environmentally friendly. The components of the range are manufactured using either sustainable sources or recycled materials and have been produced to ensure that all parts are biodegradable, recycled or recyclable.



## Inspiration

Stocking great quality products is key to success but it is equally important to make them look good. Their dedicated marketing team will ensure that your product offering is showcased effectively, attracting customers and inspiring them to decorate with confidence.



## Innovation

Using their wealth of experience they constantly look to develop products that are genuinely innovative and represent a balance of functional, ergonomic and eye-catching designs to set themselves ahead of the competition.



## Decoration

Their mission is to make decorating easier, more efficient and more enjoyable. They are best known for their paint brushes, rollers and tools but their range extends far beyond this. Their extensive product selection offers a solution for all types of users, whatever task they are attempting.



high quality **Paint Brushes**



**TOUGHBUILT™**

www.toughbuilt.com

We create innovative products that help you build faster, build stronger and work smarter. How do we do it? We listen, we research how professionals work, then create tools that help them save time, save hassle and save money.

**TOUGHBUILT INNOVATION**

When you check out a ToughBuilt product, you'll probably think "I wish I'd thought of that." In a way you did. Because before we start designing, we spend hours watching guys like you at work. Then we try to figure out how to make your life better at work. Creating the best tools takes time but we promise there is much more coming.

**TOUGHBUILT QUALITY**

It's been sharpened, oiled, worn smooth and still works like the day it was made. That's the kind of tools we make. We design every ToughBuilt product to last. We invent, engineer, test and verify every ToughBuilt product in the USA and manufacture every one to our strict quality standards and with a Limited Lifetime Warranty.

**TOUGHBUILT PRODUCT RANGE**

- Hand tools
- Tool Bags
- Tool Belt
- Sawhorse
- Tool sets
- Tool Pouch



مؤسسة الفجر  
al fajer establishment

A MEMBER OF AL FAJER GROUP

www.fajerest.com

# ToughBuilt

is inspired by you and is designed from its inception to create products that make your work easier and more efficient.



Hand Tools



Tool Bags



Tool Belt



Sawhorse



Tool Set



Tool Pouch



www.tactix.com.my

Since 1992, Meridian International, an ISO9001 accredited company, has successfully established itself as one of the leading organizations serving the tool and hardware market, becoming the headquarters for an effective group of manufacturers with the proven capabilities of serving global customers. Such ability can be attributed to the synchronized approach to manufacturing taken by Meridian, following a collaborative process of internal research, product development and graphic design together with proven sourcing, manufacturing and distribution capabilities.



مؤسسة الفجر  
al fajer establishment

A MEMBER OF AL FAJER GROUP

www.fajerest.com



### Meridian Products Range

- Fastening
- Striking
- Measuring
- Layout
- Cutting
- Cementing & Painting
- Finishing
- Tool Bag
- Plumbing
- Automotive
- Electrician
- Knife & Multi-Tool
- Lock
- Torch
- Miscellaneous
- Tool Set

We provide  
quality tools  
in the sphere of  
opportunities





www.durostick.gr

DUROSTICK was founded in 1988, is among the most successful and financially healthy businesses (it holds the first place among competitor companies) in the Greek construction chemicals Industry. the daily production capacity in relation to adhesives and paints exceeds 600 tones in weight.

DUROSTICK is certified under ISO 9001:2000. DUROSTICK products are labeled with CE certification when required.

The corporate and brand identity of DUROSTICK and its products is widespread and visible to both the construction professionals and workers while it is a household name with the vast majority of consumers.

DUROSTICK thanks all of you who have contributed to our growth to this day and will continue to do so in the future to the mutual benefit of us all. it is our promise that the continuous improvement of our products and solutions we provide, our constant focus on the needs of partners and end-users of our products was, is and will always be our non-negotiable goal.

### We have range of products for maintenance in following categories

- Tile & Marble Products
- Sealants – Tools & Waterproofing Material
- Plumbing Products
- Adhesion Products
- Improving Agents & Special Mortars
- Primers & Paints
- Cleaning & Protection



مؤسسة الفجر  
al fajer establishment

A MEMBER OF AL FAJER GROUP

www.fajerest.com

# for every use there is a solution





E-mail: [paints@fajerest.ae](mailto:paints@fajerest.ae)

Among the prestigious companies for which we are the sole agent in U.A.E are **San Marco (Italy), Novacolor (Italy), and Atria Floor (Italy).**

All over the world, the most evolute architects and designers, as well as the general public, choose San Marco as we expertise for the last 50 years of continuous growth, owing to our focus for technological and innovative products. Our products can be the best solution to decorate luxury hotel suites, commercial centers, old stylish villas, elegant boutiques.

A complete range of quality decorative products it's available with us in base form or coloured with a special San Marco and Novacolor tinting system. The decorative products like Stucco Veneziano, Marmorino Classico, Marmo Antico, Grasseello di Calace, Sil-tech Perlaceo, Cadoro, Marcopolo, decori Classici etc. Our expert team of technicians and appliers contribute to the timely completion of projects to the satisfaction of all.



**Brands:** \_\_\_\_\_





Succeeding in today's modern world means striving for excellence through passion and professionalism. Colorificio San Marco fits that bill, leading Italian producer of paint systems for the building industry. With a history dating back over half a century, we have evolved into the internationally-renowned benchmark sector company of today.

With 8 production units worldwide and 7 brands, the San Marco Group is leader in Italy's paint and varnish sector for the building industry. Our corporate philosophy focuses on the values of innovation, honesty, transparency, and social and environmental responsibility. Plus, we place a strong emphasis on the individual and job security.

We also believe in being a major player in service quality and corporate ethics. Colorificio's corporate excellence is demonstrated by our Quality System, which was certified under UNI EN ISO 9001 and the subsequent ISO 2001, known as VISION 2000. These achievements attest our commitment to satisfy our customers' needs and constantly improve our products efficiency.



*Marcopolo*



*Marcopolo Sable*



*Cadoro*



*Cadoro Velvet*

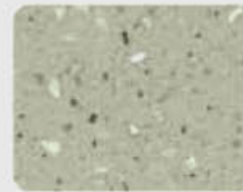

*Canalgrande*



*Acrisyl Decora*



*Rilievo*



*Grassello Di Calce*



*Stucco Veneziano*



*ABC Riflessi*



*Velature*



*Perlanceo*



**NEPTUNUS** is a ready-mixed mortar which, when mixed with water, creates a dehumidifying mortar for the restoration of surfaces affected by rising damp or the formation of saltpetre earth..

The high breathability of water vapour, together with its strong water repellence, render NEPTUNUS INTONACO DEUMIDIFICANTE particularly suited to working:

- In buildings with the aim of preventing rising damp and efflorescence.
- Indoors for the dehumidification of rooms that are particularly damp (cellars, basements) or subject to condensation.
- On facades subject to strong winds and freezing and thawing.
- As a complementary treatment to damp-proof courses.

The high breathability of water vapour, together with its strong water repellence, render NEPTUNUS INTONACO DEUMIDIFICANTE particularly suited to working:

The indicative spreading rate is 25-26 kg per sqm with a thickness of 2cm after the product has dried. This is diluted by mixing with 20% of ADDITIVO DI AGGANCIO (modifying agent).

## NEPTUNUS PROTECTION FOR YOUR HOME

Water soluble covering wall fixative for indoor and outdoor use

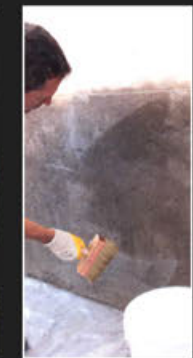

**Novacolor** was first established in 1982 in Forli (Italy). the company starts producing paints and coatings for the large consumer market, continuous plastic coatings, protective coatings and anti-carbonation paints. the factory occupies a total area of roughly 5.000 mq 2.000 of which belong to warehouse and production unit.

Decorative products for interior and exteriors, historical paints and coatings for restoration. high-tech systems for residential and public housings. responsible for the preservation of Architectural and Monumental Heritage.

**Our Product Range :**

**Dune** Decorative architectural trowel-on coating with stunning metallic patterns.

**Africa** Decorative architectural trowel, with "Silk" effect.

**Swahili** Textured metallic decorative finish for interiors.

**Teodorico** Mineral lime based coating with gold, silver and bronze highlights.

**Marmorino KS** Mineral lime based finishes for interiors and exteriors.

**Era Veneziana** Lime-based glossy stucco finish for inside and outside use.

**RustOn** Interior Faux finish with a Rust effect.

**Animamundi** Reinterprets in an innovative way a gently metallic texture with soft pearl effects.

**Antiche Patine** Earths and oxides pigments of classic vibrant transparency for precious glazing and stain effects.

**Marblestone** Lime-based mineral "stone" finish.

**Celestia** Interior decorative finish with "patina" and "soft touch" effect.

**Tuscania Antica** Polychromatic interior system with "patinas" effect.

**Tuscania Antica effetti** Polychromatic interior system with "pearl" for interiors.

**Tuscania** Interior decorative waxes for glazing finishes.

**Favrite** Water-based polychromatic interior decorative system.

**Casa Veneziana** Acrylic paste for Stucco Veneziano effects for interiors.

**Cera - Wax** Synthetic wax for polishing treatments over Marmorino and Stucco Antico.

**Marmor Fine and Medium** Mineral Lime-based finishes for exteriors and interiors.

**Cera Gold, Silver & Bronze** Synthetic Paste with gold, silver or bronze effects.

**Arctic A** Finishes for interiors and exteriors with E.B.S. technology.

**Wall 2 Floor** Seamless stone covering for walls and floors.



Since 1972 the company of Atria brothers had the ability to plan for investments in productive resources to obtain better product quality, best value for money and utmost professional service to clients. This is why the company adopted in 1997, a quality system in accordance with ISO 9002 and in 1999 the first Italian company in the industry, an environmental management system in accordance with ISO 14001 certified by DNV, an organization internationally accredited certification SINCERT Italy.

Atriafloor isn't simply a decoration, but it represents an accurate, new, charming solution of style, composed by endless combinations of techniques, expressions and colours. A fresh and fancy way to decorate which will allow you to fulfill what until now was only imaginable. Every flooring may have thousand shades and lots of combinations of application techniques. From the classic to the modern, passing through ethnic and contemporary, every style finds in Atriafloor the most congenial partner Decorative flooring.

### Our Products

- Varnishes
- Glazes
- Thermo insulating paints and coverings
- Paints
- Water paints
- Water varnishes
- Enamels



is the **Atriafloor**  
**innovative**  
way to furnish  
**your house**

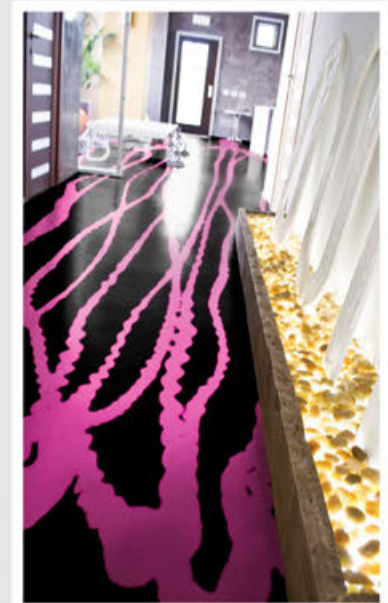



www.tupomachinery.com

Foshan Tupo Machinery Manufacture Co.,Ltd locates in FOSHAN city of Guangdong Province China, where it is about 50 km from Guangzhou Airport and about 25 km from Canton Fair complex. The company focuses on the new innovative machinery in construction industry and keens on the research & development and manufacture of rendering machine for more than 9 years. We are the original inventor of Automatic Rendering Machine with 5 invention patents for now and are still applying for more patents for our new generation machine.

Automatic rendering machine, also called wall plastering machine, was a new type construction machine invented by Mr.Wang Jianhu and his research group through 6 years repeatedly testing, which cost us 1,000,000 US dollars, TUPO rendering machine possesses the features of fast locating, quality plastering, fast speed, and smooth plaster surface and so on. It has a wide range of application. It is appropriate for the plaster work on metopes of commodity houses, office buildings, factories, schools and rural self-built houses. The appearance of TUPO rendering machine significantly reduces the labor intensity of plasterer, improves the plastering efficiency, and shortens the construction period which contributes the development prosperity of construction industry.

### Advangate:

1. Capable of rendering 5cm from the floor bottom to roof top
2. With two plastering board, even better planeness and smoothness
3. Located by infrared ray, more efficient
4. Operated by one worker, save more labor cost
5. Remote Control



مؤسسة الفجر  
al fajer establishment

A MEMBER OF AL FAJER GROUP

www.fajerest.com

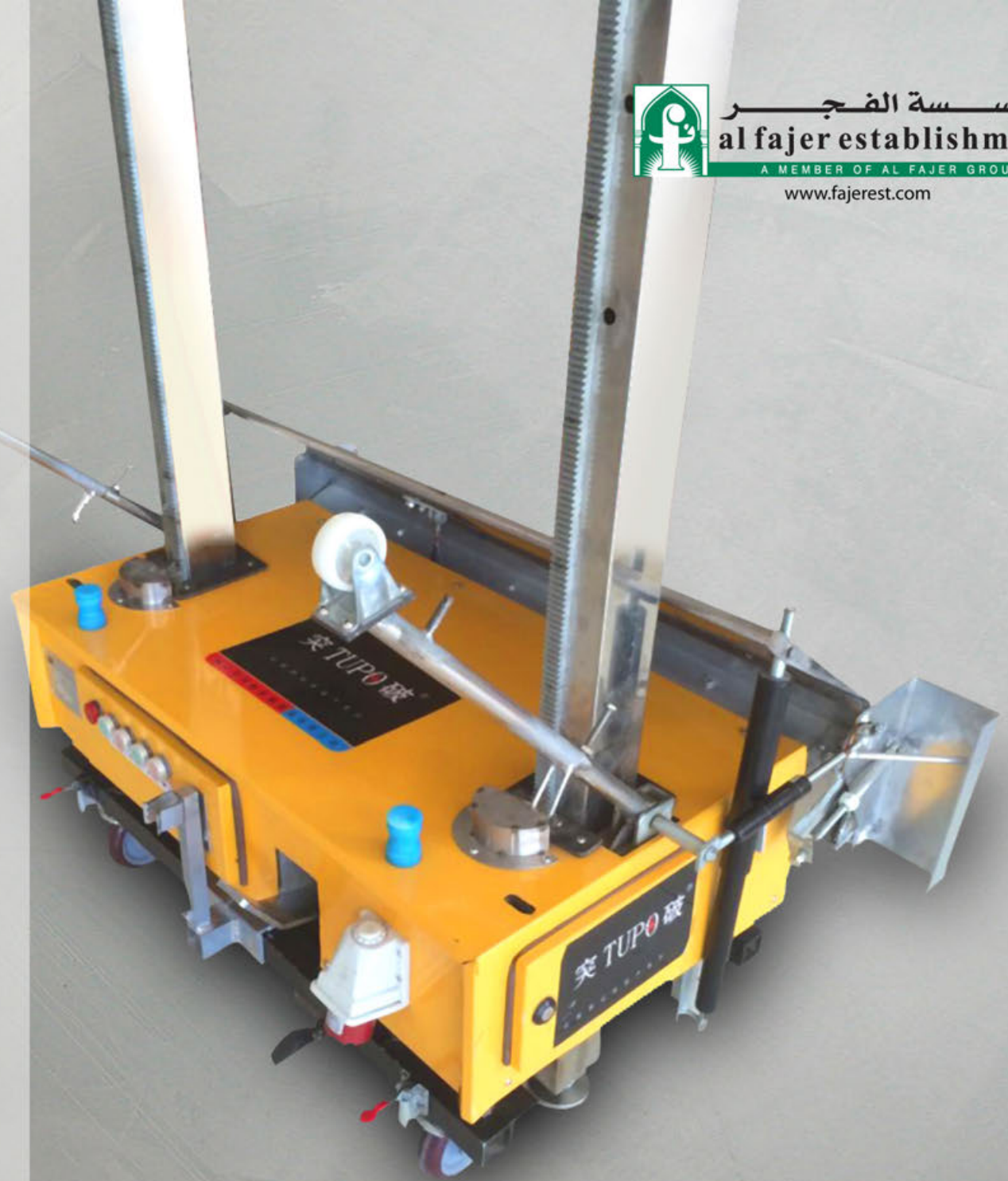

**TUPO PLASTER rendering machine**



E-mail: doors@fajerest.ae

Doors Division was started to meet the ever increasing demand for quality doors that meet the rigid requirements of the concerned authorities. We represent some of the world class brands namely COMTUR – No.1 door factory in Germany & SEAL FIRE Pvt. Ltd specializes in the design and production of a wide range of wooden products from Singapore.

We are authorized dealers by Dubai Civil Defense & hold international certificates such as EXOVA, BS & CSIRO.

Our team of expert carpenters with over 15 years of experience adds up for our success in timely completion of major projects with satisfaction from our valued customers.

Our benefit of customers coming back to us is the timely completion & satisfied installation as per the client, consultants or contractors. We would appreciate if you kindly consider us as your regular & potential supplier for all range of fire and non-fire rated doors.

We hope that our range of doors will be in line with your requirement.



**Brands:** \_\_\_\_\_



مؤسسة الفجر  
al fajer establishment

A MEMBER OF AL FAJER GROUP

www.fajerest.com





www.sealfiregroup.com



www.kosin-international.com



مؤسسة الفجر  
al fajer establishment

A MEMBER OF AL FAJER GROUP

www.fajerest.com

**Seal Fire Ltd.** (Singapore) specializes in the design and production of wide range of wooden products. Our manufacturing sites in Shanghai, Zhejiang (China) and Vietnam cover a total area of 35,000sqm. They are empowered by own in-house computerized design and production facilities, fully qualified workforce, highly capable of manufacturing high quality standard products.

The company has setup sale offices in Singapore, Vietnam, China, United Kingdom and Taiwan. AUSIN products are the results of unrelenting efforts in researches, designs and detailed production from our efficient staffs. We believe in continues pursuit of innovation, quality, efficient human resource management and production of environmentally and user friendly products.

**AUSIN** doors are designed and engineered to exact standard to meet the stringent requirements of British Standard 476 Part 22. Our products are manufactured to the highest standard and supported by independent third party approvals – Certifire Approved / ISO 9001 / BS476 Part 22 / FSC – COC Secure by Design.

### FIBRE GLASS DOORS

- High impact-resistant 2mm fibreglass skin
- Is unaffected by moisture and humidity
- Enhanced sound proofing and thermal insulation
- Compression moulded wood grain finishes with real wood effect



Approved by United Arab Emirates Ministry of Interior Civil Defense



### VOGUEZ SERIES



Exclusive Doors for Home and Business

The individual is at the center of our creative efforts. They design and realize door ideas for the home and business. And at Comtuer, they offer you much more than just doors.

Because a door is much more than just purely function element. Doors define space. Like an exclusive item of furniture they enhance every ambience.

Whether classical and elegant or modern and design oriented, in wood, lacquer or glass – together with us you will always find the perfect solution for your personal situation. And with an extensive range of exclusive designs and materials to choose from, the possibilities are literally endless.

Service and passion, craftsmanship and tradition, know-how and innovation, quality and reliability – this is what we aim to offer and this is the driving force behind our exclusive products.

*Treat yourself to a real piece of lifestyle with Comtuer doors.*





Fimet Handles set up in 1986 in Vestone, in the heart of industrialized areas of north Italy, after years of commitments has now achieved a leading role in the vast field of the Italian handle manufacturing.

The company now offers handles of superior quality going along with the choices of the customers with an ideal blend of classic and modern, being instrumental in the competition with the other companies.

The satisfaction of the increasing needs of the customers is for Fimet motivating force for a steady quest of new solution to find the most innovative handle and this make of it one of the leading companies in the production and merchandising of handles.

- The range is characterized by an extraordinary variety of handles and coordinated accessories. Their products are developed to meet consumer demand in all the market we work.
- The wide variety of handles has been created thanks to the needs of our customers. Infact when they need new models, they develop new ideas, they realize the prototype in resin and when the model is approved we start the production.
- Thanks to their capacity to work with many countries and various type of customers we are able to satisfy any demand in terms of technical requirements.
- Quality controls are made both during the production and the assemblage of our products.





Sunware Manufacturing Co, Ltd. specializes in producing door and window hardware for more than a decade. They are dedicated to providing our customers with high quality door locks, hinges, door knobs, pull handles, door stoppers, flush bolts and door guards. Our range includes residential, commercial and architectural door hardware.

Also featuring a wide variety of door hardware accessories to compliment your door knobs, handles, levers and locks. Choose from door holders, ball catches, kick plates, push plates, door pulls, door knockers, door viewers, mail slots, house number, pocket door accessories and more.

Our architectural hardware products not only look good, they feel good. We continually strive for a combination of quality and aesthetic which will stand the test of time.

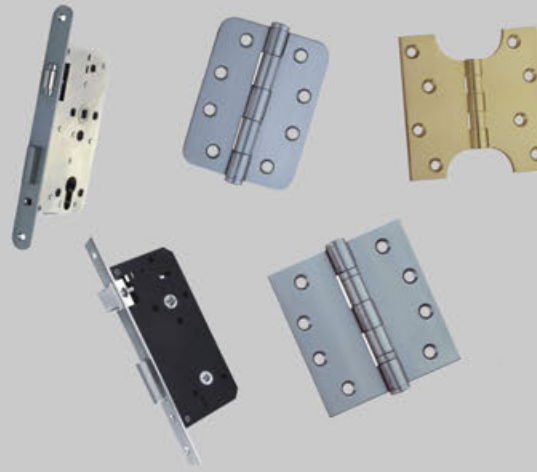

مؤسسة الفجر  
al fajer establishment  
A MEMBER OF AL FAJER GROUP  
www.fajerest.com



Eurospec was launched in 1997 as a subsidiary of Carlisle Brass Ltd. Over a period of 15 years Carlisle Brass Ltd, through frequent forays around European manufacturers, had accumulated a vast experience and knowledge of the extensive range of quality products and services available to them, many of which did not fit in with the product profile or expertise of the established company.

The 'Eurospec' concept evolved as a solution to this dilemma: An autonomous company specialising in the more commercially orientated sector of the architectural ironmongery market. The combination of a 'European Quality' product range and technically experienced staff geared towards the specification requirements of the industry proved an effective recipe and established the foundation on which Eurospec has grown and developed since.

Quality engineered architectural products at realistic prices including Security Locks and Cylinders, Stainless Steel, Aluminium and Brass. All available ex-stock and on a next day delivery service have further cemented this foundation, making Eurospec one of the leading wholesalers in the UK today.

Eurospec is constantly striving to improve and develop its range and the appeal of its products and to accommodate the ever-shifting trends of the market. Our current short term and long term program is hugely exciting and promises even better things to come.

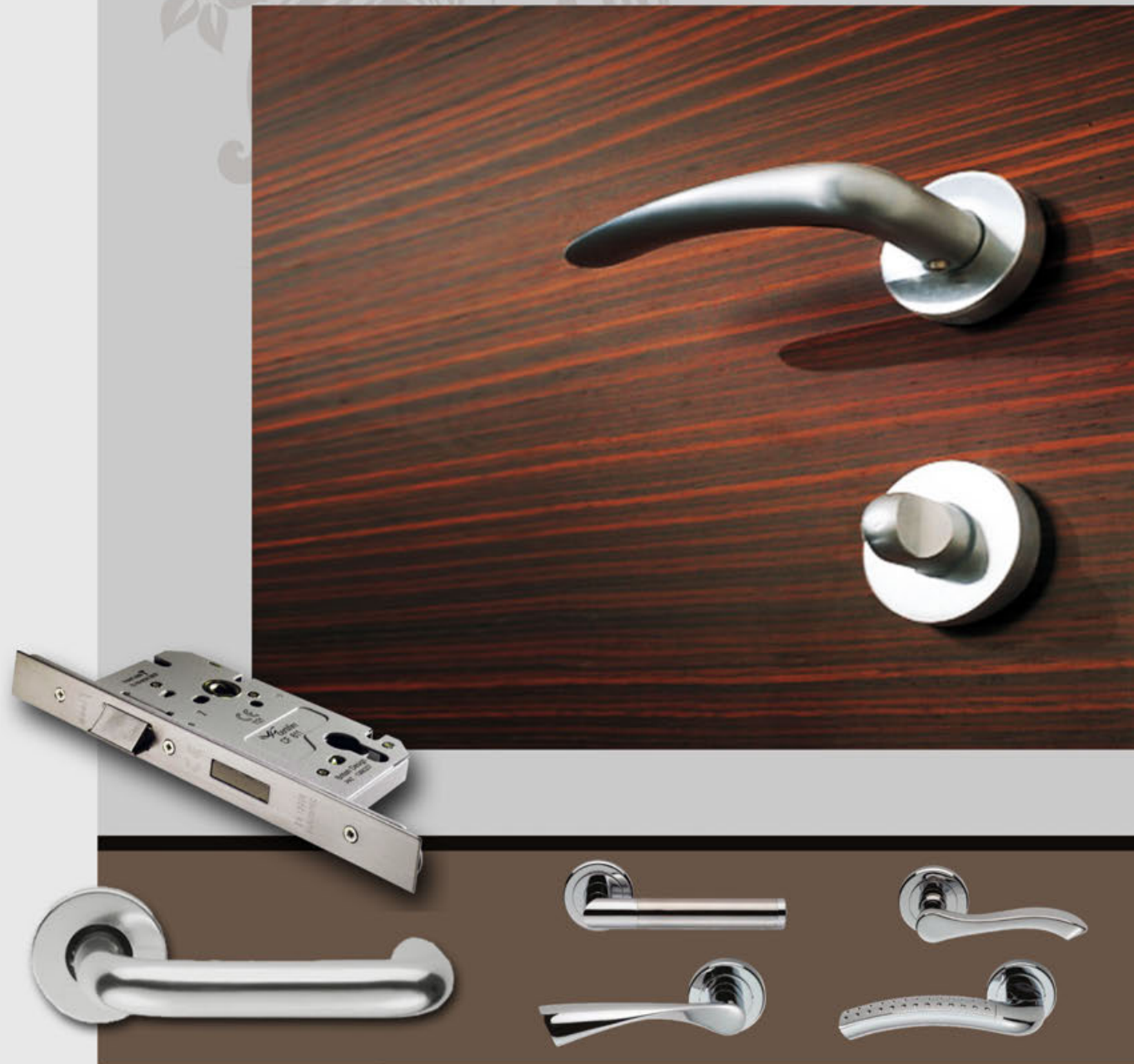

Interior Design Division is committed to provide client focused design solutions. Our team strives to create unique authorized interior design solutions and execute the same with utmost care regarding quality and design.

Over the years we have been involved in diverse range of projects, creating exciting environments for local and multinational clients in the Middle East. We make sure that we deliver each project within the specified time frame and budget.

We take pride in having a team from various multinational backgrounds who are expert with extensive international experience and local market knowledge. Since its inception, we have put together a remarkable portfolio of project ranging from residential through a variety of commercial and institutional complexes.

We are here to provide you the leading edge quality of design from concept through completion.



Brands:

 **MCYI** 美溢  
 **Kcolor**  
INDUSTRIA & WOOD



Established in 1990, Huayi Zhongzhi Decoration Materials Products Factory has been dedicated to producing translucent stones for many years. With our professional employees, we assure that our high quality products are made according to national standards.

with many excellent characteristics such as good transparency, good rigidity, impact endurance, not flammable, easy machining and anti-UV availability, can be widely used for Villa and Home decoration project, Offices, Hotel, Clubs, Store.

### Product Features

- Unique patterns
- Many Colors and Pattern
- Long Life Time
- Heat Insulation
- Easy Installation

## Innovative style

Wide range of design style and performance ability

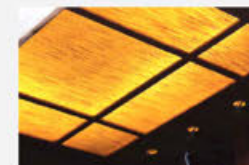

Colorificio KCOLOR is an Italian manufacturer of paint systems for metals and anticorrosion functions since 1978. Colorificio BICOLOR has over 35 years experience in the world of paints. Born as a manufacturer of coating systems for the building industry, over the years has specialized in offering paint systems for metals and anticorrosion functions. Since 1997 operates under quality certified system according to ISO 9001.

Our range of Gold and Silver solvent-based paints for outdoor and indoor applications are of very high quality with brilliant effects.

### Our Products

- Gold Silver Collections
- Industrial Building
- Tinting System "Kappatinto"
- Road markings paints
- Wood
- Special coatings for paper and rubber

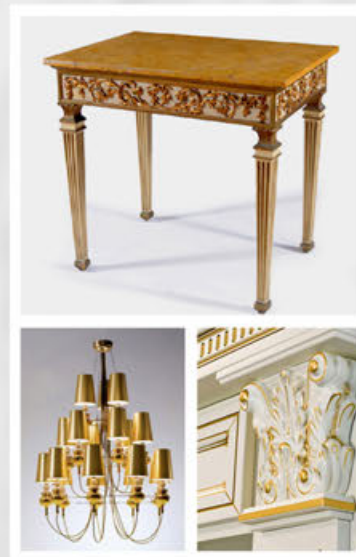

## high quality brilliance effects

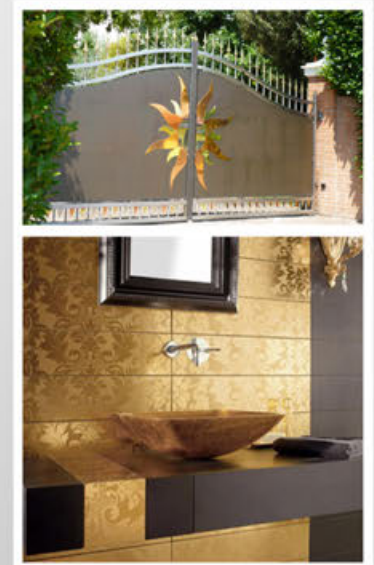

# POSH FURNISHING PTE LTD.

[www.poshfurnishing.com](http://www.poshfurnishing.com)

Posh Furnishing is the furniture division of Seal Fire Pvt Ltd. Based in Singapore, Vietnam and China.

We strive to provide finely crafted luxury furniture with impeccable design and quality and legendary service to our customer.

Each of our customers is unique and has their own tastes when it comes to the décor for their home or office. That's why we work closely with you to understand your individual needs, whether its styles, fabrics or colors.

All of our products are aesthetically pleasing, finely crafted with top quality materials, and extremely functional. It is our goal to help everyone incorporate great design into their everyday lives, bringing style and elegance to their home or work environment.



## HAND RAILS AND WALL PROTECTION PRODUCTS

Shaoxing Siwell Plastic-Cement Engineering Co. Ltd. is a professional manufacturer of such plastic products as impact resistant handrails, corner guards, wainscot boards, corridor handrails, dash-proof hand-guards, medical hand-guards, free handrails, and dash-proof materials.

We have established researching cooperation with university experts and technicians in the field of plastic-mould research, plastic product design and manufacture.

Thier factory is equipped with polymer material extruders, plastic injectors, anti-shock pads and other advanced facilities. With specially-designed die-cavity structure, our impact resistant products are closely batched with aluminum alloy. They are beautiful, fireproof, impact resistant, antibiosis, and antiseptis.

Their products are widely applied in hospital, hotels, aged people's apartments, schools, airports, and offices. We are devoted to providing excellent product quality and satisfactory services which includes installation and maintenance.

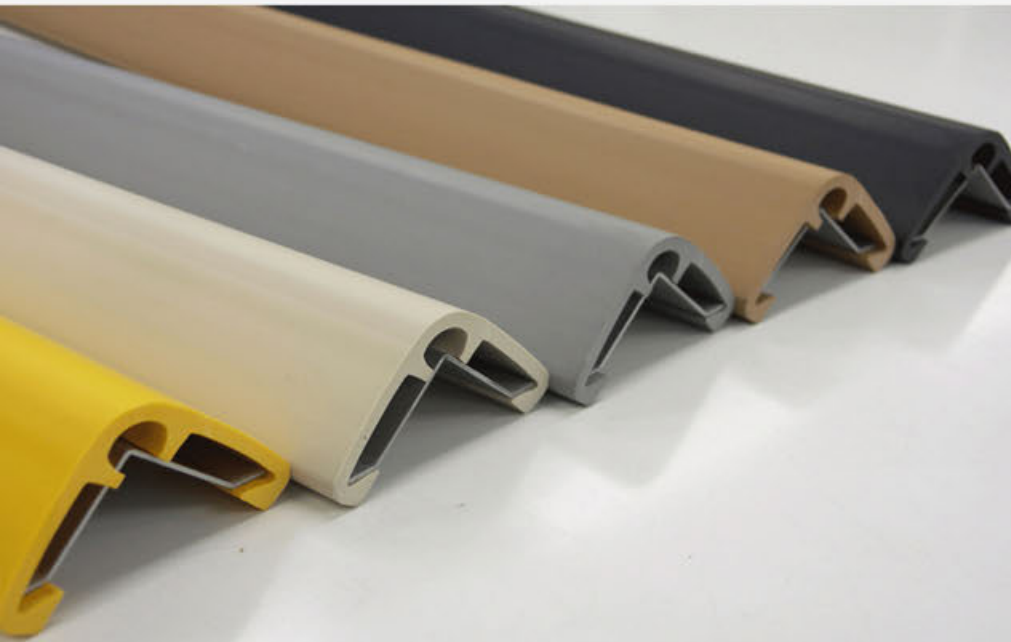





**HOSPITALS**



**COMMERCIAL**



**OFFICES**



**RESIDENTIAL**

Security Solutions & Equipment division of Al Fajer Establishment mainly representing Security Screening Products. Al Fajer Establishment is the authorized distributor and Service provider for Astrophysics & Sentry Safe and also the authorized reseller for Ceia & Garrett products.

With its recent venture the Security Solutions & Equipments Division, Al Fajer Establishment aims to cover the security electronics market in UAE. By representing leading brands and providing state of the art technology in the field of mass protection, we aim not only to be a provider but also excel in after sales services and maintenance.

## Smarter Security Solutions



- Airports
- Hotels
- Embassies
- Military Bases
- Police Stations
- Banks
- Post Offices
- Freight Forwarders
- Corporate Office
- Private Couriers
- Museums
- Sporting Arenas

Brands: \_\_\_\_\_





**ASTROPHYSICS**

www.astrophysicsinc.com



مؤسسة الفجر  
al fajer establishment

A MEMBER OF AL FAJER GROUP

www.fajerest.com

Astrophysics Inc. is a leading designer, developer and manufacturer of security x-ray inspection equipment for baggage and cargo screening.

The Astrophysics XIS Series offers a diverse product line designed for every application from mailrooms to multi-purpose security checkpoints, and large-scale cargo screening.

Astrophysics has an extensive support base of over 7,000 units across 100 countries and more than 1,000 customers.

ASTROPHYSICS's Innovative Multi-View Imaging Technology 'VI7' generates a series of 7 high quality images of the screened object, each showcasing a different angle.

The VI7 features a display that rotates through the 7 images, each showing the same bag at a distinctive, unique vantage point. It therefore enhances the operator's 3D awareness and overall depth perception. Items that may have been hidden in one view become clearly visible in another.

## TOMORROW TECHNOLOGY FOR TODAYS SECURITY



Sentry® Safe was founded in 1930 in Rochester, New York, USA.

Sentry Safe is the largest residential and light commercial safe manufacturer in the world, with production facilities in USA and China, and has worldwide distribution in more than 50 countries.

Sentry Safe is manufacturing chest, files and safes for the home and office with a superior design and finish with varying features and benefits at logically progressing price points.

All fire-resistance Sentry Safe products come with a lifetime after-fire replacement guarantee

### Sentry Safe Products Range

- Home Safes
- Hotels Safes
- Business Safes
- Commercial Safes
- Gun Safes



## KEEP IT SAFE





E-mail: fajerest@eim.ae

A safe work environment is the key to high performance. Many industries and sectors like engineering industry, automobile industry, chemical industry, hospitals, construction industry and many more need to provide special protective wear for their employees, as the possibility of accident is high.

Al Fajer Establishment, Safety Division has been successfully catering to the requirements of these industries efficiently. We are recognized as a

As a result of our efforts and a dedicated approach towards customers, we have established a wide reputation in the UAE market. Our Professionals make sure that goods are competitively priced and delivered on time. Driven with a motive of ensuring complete customer satisfaction, our professionals work closely with the clients to understand their needs and requirement.



## Brands



مؤسسة الفجر  
al fajer establishment

A MEMBER OF AL FAJER GROUP

www.fajerest.com





www.hochikieurope.com

Hochiki is distinguished by the experience and expertise of more than 80 years as one of the world's largest manufacturers and suppliers of industrial fire detection products.

Hochiki Corporation was founded in Tokyo in 1918 with most of the major Japanese insurance companies as founder shareholders.

Hochiki Corporation undertakes design, manufacture, installation and maintenance of fire alarm systems and produces in excess of 3 million units per year. An international market leader in the manufacture of fire protection products Hochiki Corporation also produces fire extinguishing, security and cable television systems. The Company employs some 1,300 people, has 3 manufacturing plants, 35 sales offices and 13 subsidiaries in Japan.

## Products Range

Fire Alarm System, Fire Detection System, Intelligent Audio & Visual Intelligent Sensor system, Smoke Detection System, Beam Detection System, Heat Detection System, Building safety system

## Sectors:

- Industrial
- Health
- Transport
- Leisure & Entertainment
- Education
- Commercial & Retail
- Historic
- Government & Administrative



مؤسسة الفجر  
al fajer establishment

A MEMBER OF AL FAJER GROUP

www.fajerest.com

# providing high quality fire

## detection products from Hochiki

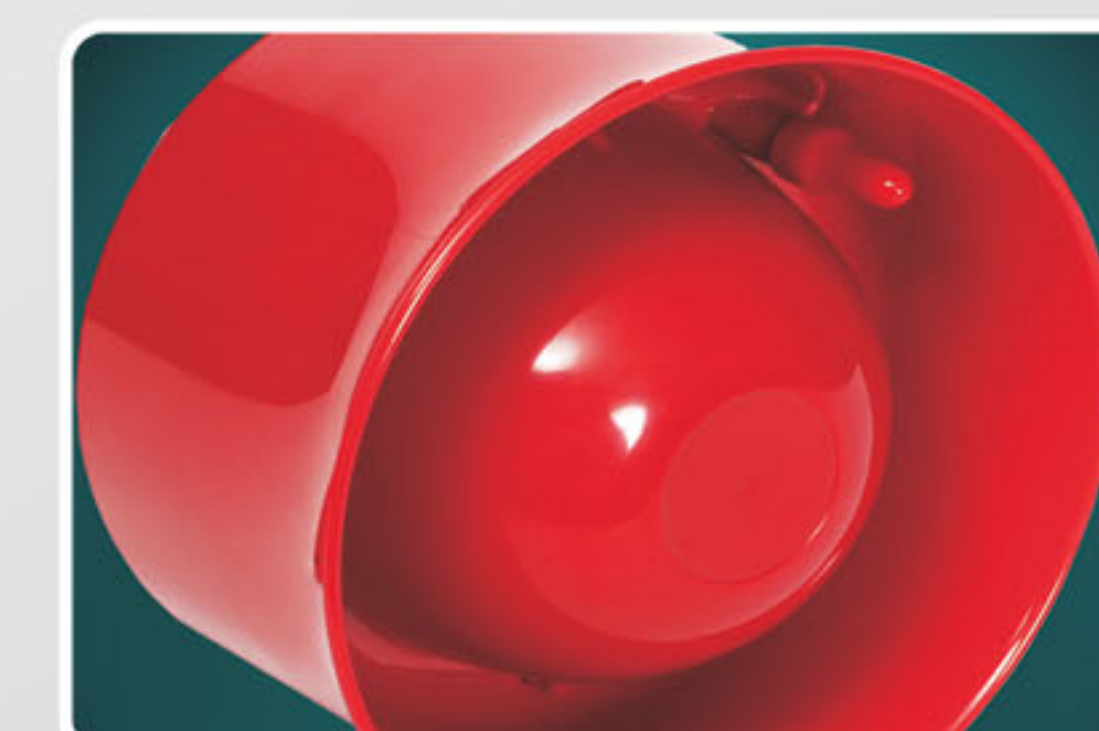



www.jmmotors.kr

Since its establishment in Korea year of 1998, Jinmyung21 has been devoted solely to the automotive industry and has accumulated extensive know-how and technological expertise.

In starting fresh and taking on new challenges for the 21st century, our goal is to become a company that is most trusted by our customers in the global community.

We will realize this goal without fail as the world's leading automotive parts maker specializing in module assemblies in line with our motto "We can do it," while banking on the indomitable spirit of the Korean people and relentless pursuit of challenges ahead.

We can create the best automobile, Pump, Portable Fire Fighting Pump, Underwater Cleaning System, Water Pump, Fire Pump, portable pump, rotary pump, rotary positive displacement pump, high pressure pump, mid pressure pump.

## Tomorrow's Technology for Today's Safety!

Fire in High rise building, Disaster in Remote Areas (island, mountainous region, jungle, rural region etc.) Difficulty getting through narrow alley in traditional markets Predicament of complicated usage with Syscuc.

Model: SYSCUC 400M



Model: SYSCUC 400EL



مؤسسة الفجر  
al fajer establishment

A MEMBER OF AL FAJER GROUP

www.fajerest.com

## APPLICATIONS









[www.fireacoustic.com/](http://www.fireacoustic.com/)

Fire Acoustic Seal Pte Ltd has years of experience in the design, development and manufacturing of passive fire protection products. We offer a comprehensive range of SEALZ intumescent, acoustic and draught seals with proven performance and design efficiency.

Our mission is to enhance the value of doors in whatever and wherever they might be.

We started from a small company that provides seals to local clients. We have grown to become what we are today, our customer base has expanded internationally and SEALZ has become a reliable name in Europe, Middle East, Asia and Australia.

Our brand signifies quality and standards in this industry. It is the most important task of any seal application is finding the right seal for the right job. Our research has shown that the four most common criteria used to select door seals and extrusions are performance, aesthetics, ease of installation

### Product Features

- Sealz Hinge Pad
- Sealz VP Glazing Gasket
- Sealz Intumescent Letter Box
- Sealz Fire Rate Auto Door Drop Seal
- Sealz Smoke Seal
- Sealz Lock case Pad
- Sealz Strike plate Pad
- Sealz Acoustic Perimeter Seal

## The Solution to your fire door is with Sealz



# Other Safety Products & Equipments



مؤسسة الفجر  
al fajer establishment

A MEMBER OF AL FAJER GROUP

[www.fajerest.com](http://www.fajerest.com)



Al Fajer Establishment has a selected range of elegant control products to make Homes, Offices and Hotel designs simple and smart.

Home Tech Division works with you to realise your dreams for the environments in which you work, live and relax.

Our accredited technicians consult, design, program, install and support the system of your choice.

Our knowledge and experience means we design a system solution that falls within your budget.

Overall we focus on tried and tested solutions. This is why we are accredited with the brands such as Kristil and ABI.

Significant stocks are held at our modern warehouse to support the after sales and the extensive distribution network.

We provide high quality systems that are tailored to the individuals requirements.



Design & Drawings



Surveillance



Lighting



Access Control



Entertainment



Energy Management



Security



Interfaces & Software

**Brands:** \_\_\_\_\_

## Upgrade your home!

Kristil home automation that allows you to control audio video, lighting and home appliances from the palm of your hands.



“the smart way to control your home”



Kristil's simplified home automation control system is designed to add sophistication and value to your new home, while minimizing energy consumption.

Kristil's industry experience goes back over 10 years when they were installing security systems and other imported automation systems.

Kristil looks forward to guiding you through the design process and developing Kristil system that means your expectation and budget.

### Our Products

You would like Kristil's intelligent lighting control and combined security system. Or, how about multi room audio or home theatre? Whatever the extent of your system, it can be easily controlled with a variety of easy to operate devices.

- An Integrated Control System
- Lighting Control
- Video Distribution
- Audio System
- Media Centre
- Camera Surveillance
- Security System
- Entry Control System
- Communication System
- Air Conditioning Control

## HVAC Management Systems

Make sure your home is specifically tailored to your needs and designed with the little things in mind.



## “advanced control products”



# SYSTEM Integrators



Mirror Image is the LCD Engine that drives images through glass to deliver superb picture quality.



**Australian  
Institute of  
Architects**

Lockwood Proud Partners

**Axiom**



The Axiom 450 Series multi-room amplifier is one of the most advanced, dedicated multi-room amplifiers in the market.



Most successful distributor of  
CCTV, IP, Access Control and  
Intuder Detection Solutions.



Company specialized in  
manufacturing products and  
devices aimed at perimeter  
security and anti-intrusion systems.



Mercury, Screen ceiling tilt



With just one touch of your finger, Pronto lets you control your living and working environment simply and intuitively, thanks to the unique concept and advanced technology of Pronto.



The i-Trak Long Range VID reader makes motor vehicle access control fast and convenient.



VID Long Range Reader



Windscreen Tag

In ECOCAR DIVISION we deal with environmental friendly electric vehicles with no carbon emission to serve our society for cleaner and safer surroundings.

We believe that we can supply one of the best electric golf cars in the market, provide after sales service and support the parts and any breakdown through our team of technicians.

Here in UAE we supplied to many individuals and hotels like The Meydan Hotel Dubai, Armed Forces Officers Club & Hotel, Khalidiya Palace Rayhaan by Rotana, Abu Dhabi National Exhibition Company and Sharjah Chamber etc

quality customer  
**service** expert knowledge



Brands

**Golf Cars**  
 & **mobility scooter**



مؤسسة الفجر  
al fajer establishment

A MEMBER OF AL FAJER GROUP

www.fajerest.com



www.excar.com.cn

In EcoCar Division we deal with environmental friendly electric vehicles with no carbon emission to serve our society for cleaner and safer surroundings.

Excar relies on the understanding and awareness of golf cart industry to build a famous made-in-China brand profited from American technologies and imported brands spare parts for an optimal configuration and best performance.

Excar products portfolio includes multi-passenger shuttle vehicles such as 2-seater, 4-seater, 6-seater, 8-seater for transportation and also utility vehicles with different models and options.

We are offering high quality products, provide after sales service and support the parts and any breakdown through our team of technicians.

### Products Features

- ADC Motor 48v/3.7Kw (USA)
- USA Trojan Battery 6x (8v/170Ah)
- Curtis Controller 400A (USA)
- Transaxle (Italian Graziano)
- Automatic Charger 48v/17Amp
- Aluminum Chassis
- LED Lighting System



## Eco-Friendly Electric Vehicle is the best choice for our planet



EXCAR Spirit Excellent car

Marshell a world-class manufacturer of electric vehicle, owns 80,000 square meters of workshop.

Electric mobility scooter from Marshell. The mobility scooter is popular with senior people, safe, adjustable, comfortable, mainly used on the shopping malls, airports, exhibition halls as well as disabled people usage.

Easy to operate to move forward and backward. Adjustable seat and can be folded.

## Products Features

- Standard color Blue & Red & Black
- Free-Maintenance lead-acid battery (12V/45A)x 2
- Motor: 24V/500W
- Automatic Charger: 24V/5A
- Curtis Controller: 24V/70A
- Brake: Electric brake
- Carrying Capacity: 120Kg
- Speed dial: (Low/High) speed

## Product Accessories

Lighting system, Front basket, Side mirrors  
Horn, Reverse beeper, Battery condition meter



a world-class  
**manufacturer** of electric vehicle and scooter



mobility scooter



CT&T is manufacturer of Electric Golf Car and Street Car from South Korea. CT&T product portfolio includes commercial utility vehicles and multi-passenger shuttle vehicles 2-seater, 4-seater, 6-seater, 8-seater.

CT&T has supplied to many countries like USA, Canada, Japan, UAE, European countries as well as more than 80% of Korea local market.

CT&T buggies are ideal environmental friendly transportation means to be used in Hotels, Resorts, Airports, Factories, Warehouses, Parks, and also for individual use in gated communities, villas, farms etc.

## Products Features:

- Powerful AC 48-volts motor with 4.3 Kw
- Heavy duty batteries last 50 KM or 8 hours of operation
- On board battery charger
- Independent suspension and shock absorbent on all 4 wheels
- 4-wheels hydraulic brake with low maintenance
- Electromagnetic parking brake
- Aluminum wheels
- Automatic brake lock when the vehicle is switched off
- EPS; electric power steering system for smooth handling
- Excellent climbing ability up to 27 degree inclines
- Automatic deceleration system in gentle/steep slopes
- Maximum speed 25 Km/h
- Lighting package including headlights, taillights, brake lights, turning indicator, horn
- Accessories like all weather enclosure, summer seat cover, side mirrors, front basket, overhead net, clock, beverage holder and ashtray

## Convenient Features and options



Al Fajer Establishment is proud to be associated with Fiskars, the company which is a global brand for the manual gardening tools, the company has now grown into a large multinational corporation.

Celebrated for a history of products accommodating the strict Finnish standards for quality & design. It guides us to create Ergonomic, Light-weight, yet powerful & Durable products.

Fiskars ergonomic, high performance cutting & landscaping tools are designed to do the hard work.

Today, Fiskars is best known for its consumer products, such as scissors, knives and garden tools. These products are organized in many divisions like Craft, Garden, House wares and Outdoor Recreation etc.

Al Fajer Establishment also with Fito Seeds, the SEMILLAS FITO is a multinational seed company established in 1880, with a clear landmark in the Mediterranean basin, Middle East and Latin America. It is organized in four divisions: Vegetables, Field Crops, Hobby and Green Areas. They believe in Innovation, Research and Development as their main pillars and drivers o



Brands:

**FISKARS**®  
Since 1649

**SEMILLAS**  
**fito**



# FISKARS®

www.fiskars.com

**Fiskars® Garden Tools is the number one global brand of garden tools.** Fiskars is a leading brand that provides functional, user-friendly and lasting design solutions for hand tools and beyond. Fiskars products respond to genuine inspiration and drive to get the job done well in the most effortless and intuitive way.

Established in 1649, Fiskars is the oldest company in Finland. We have worked with tools, cutting and steel forging ever since we first started operating 360 years ago.

Our roots are in the Fiskars village, an idyllic center of art & design, where modern aesthetics meet old crafting traditions. Fiskars launched the world's first plastic-handled scissors in 1967.

Since then, these orange scissors have sold more than 1 billion pieces worldwide and their iconic status has resulted in the Fiskars orange being synonymous with scissors across the world. Fiskars is the world's number one scissor brand.

Fiskars is a leading global supplier of consumer products for the home, garden and outdoors. The group has a strong portfolio of trusted international brands, including Fiskars, Iittala, Gerber, Silva, and Buster.

Al Fajer establishment are proud to be the Sole Distributor of FISKARS in the Middel East, GCC countries and Iran.



مؤسسة الفجر  
al fajer establishment

A MEMBER OF AL FAJER GROUP

www.fajarest.com





www.semillasfito.com



مؤسسة الفجر  
al fajer establishment

A MEMBER OF AL FAJER GROUP

www.fajerest.com

Semillas Fito is a Spanish multinational that was founded in 1880 in Sant Marti de Provencals, Barcelona. Over the course of the last 130 years it has gone from being a small family seed enterprise to one of the biggest multinationals in the field of genetic improvements and the production and distribution of seeds for horticultural and field crops.

Our commitment to the company makes Semillas Fito a unique company: working hand-in-hand with farmers and other professionals in every sector where we operate to develop and improve seeds together, always responding and adapting to the needs of each individual client.



## Products:

- Eggplants
- Peppers
- Tomatoes
- Melons
- Watermelons
- Cucumbers
- Squashes
- Peas
- Broad Beans
- Beans
- Onions
- Radish
- Carrot



Vegetable  
seeds





E-mail: [printing@fajerest.ae](mailto:printing@fajerest.ae)

Al Fajer Establishment Printing Division is consistently expanding by adding new value products.

We have always endeavored to provide the printer with quality products, support services and information representing the latest and most advance graphic art technology. The categories of products include complete range of Offset Process Inks, Pantone Inks & Varnishes, U.V Inks, U.V Flexo Inks & Varnishes/Flexo, Roto Graviure Inks (Solvent& Water Base), Reprographic Materials & Chemical / Pre Press Chemical & Complete Material Connection with Post Press



مؤسسة الفجر  
al fajer establishment

A MEMBER OF AL FAJER GROUP

[www.fajerest.com](http://www.fajerest.com)



## Brands

SunChemical



HARTMANN



IMPERIAL INK™



Sun Chemical, a member of the DIC group, is the world's largest producer of printing inks and pigments and a leading provider of materials to packaging, publication, coatings, plastics, cosmetics, and other industrial markets including electronic materials, functional and specialty coatings, brand protection and product authentication technologies.

Sun Chemical's unparalleled global presence allows for the delivery of local service and support that is customized to the markets it serves. Recognized as a leading source of innovation, Sun Chemical has 10 research and development centers that are committed to creating solutions that improve productivity, create new revenue opportunities for customers, and contribute to a more sustainable future.

In addition to its leadership in inks and pigments, Sun Chemical introduces new solutions that enable marketers to better manage their brand colors, protect product integrity through improvements in packaging, and introduce security features that defend against counterfeiting.

Sun Chemical also creates innovations for digital printing applications, including inkjet printing systems for narrow web and corrugated printing as well as inkjet inks specifically formulated for LED curing.

Sun Chemical Corporation is a subsidiary of Sun Chemical Group, the Netherlands, and is headquartered in Parsippany, New Jersey, U.S.A.





**IMPERIAL INK™**  
www.imperial-ink.com

The technical collaboration between **IMPERIAL INK, CALCHEM CORP** of **USA** and **INCTEC INC** of Japan has given us the confidence and commitment to meet the growing demand of our quality products and services. Together, we have more than 100 years of accumulated knowledge in technological advancement and business expansion.

We have invested in research and development (R&D), using our own dispersion technique for ink production in a technical field where traditional chemistry is no longer competitive. The development of new types of inks to meet modern printing needs is the drive and goal for the company.

The potential of **IMPERIAL INK** will shine its way with drive and confidence as we have established a worldwide distribution network in inks and other printing supplies to countries such as Hong Kong, China, Sri Lanka, Mauritius, Middle East, South Africa and the Asean region. This is the chance to thank everyone who has in one way or another, contributed to our strive and pursuit for excellence.

With your support, our first decade has met with astounding success and we hope to continue the high standards accomplished.

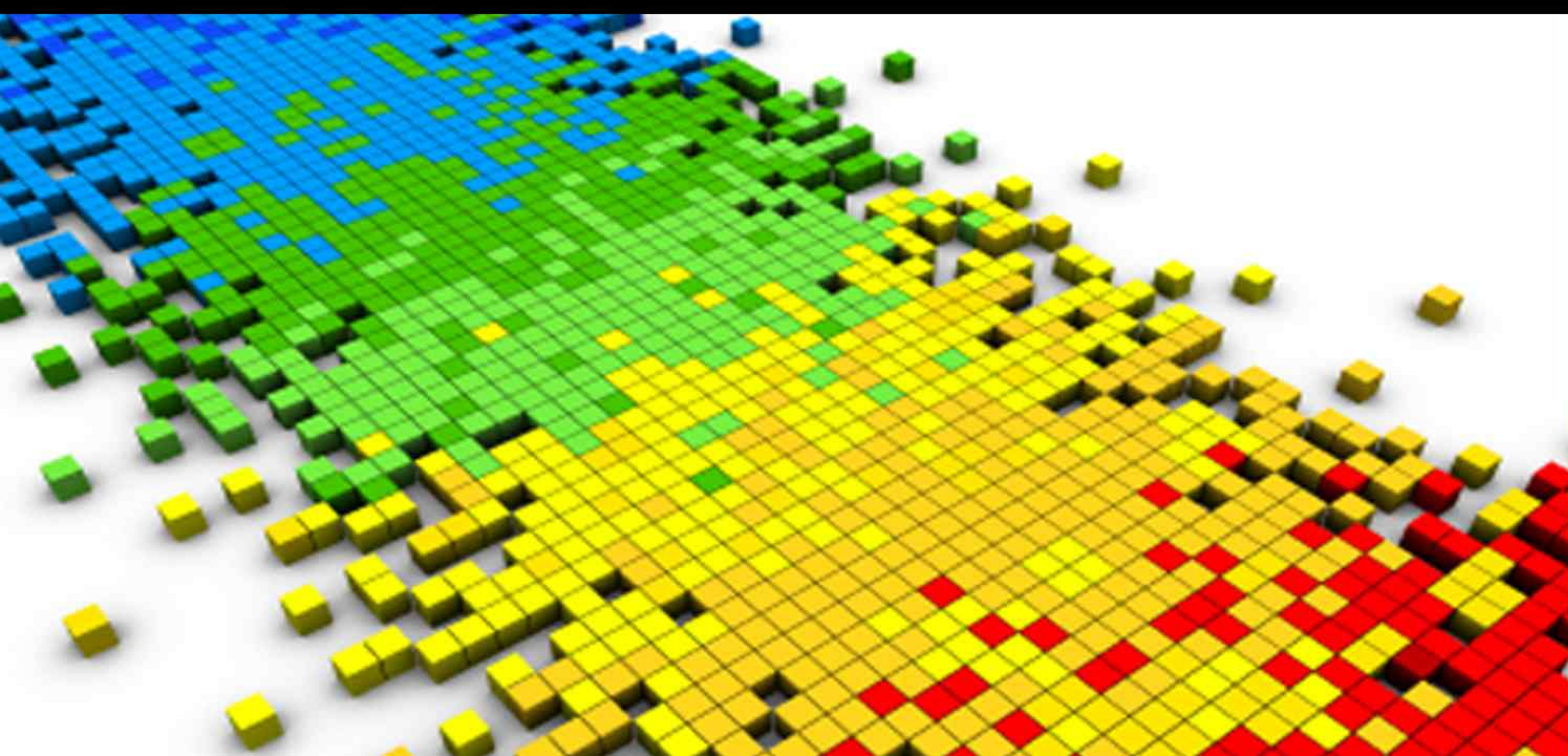

مؤسسة الفجر  
**al fajer establishment**

A MEMBER OF AL FAJER GROUP

www.fajerest.com





www.imperial-ink.com

Morohoshi Chemical was established in Japan since Year 1891. Imperial Ink recognizes the demands from printers worldwide wanting quality press-room chemicals to meet today's high standard printing requirements

Over the years, printers have used inferior products which not only under-perform but also damaged their expensive printing machine rollers. With extensive use, it will also affect the print quality.

Imperial Ink understands the need for superior and economical products. This opportunity was taken by Imperial Ink who bought over a more than 100 years Japanese brand – Morohoshi Chemical.

These technology know-hows are produced now in our factory under close supervision by our team of dedicated Technicians and QC personnel.

Morohoshi Chemical has assist printers internationally in their daily printing environment minimizing pressroom problems.

Today, Morohoshi products have found its way into 25 countries round the world. Its success is built on using high quality materials and strict quality control. Every batch of raw material is tested using our sophisticated quality control equipments to meet our own high expectation for quality and consistency.

It's One World, One Moroshoshi - Quality, Cost and Service (QCS)



مؤسسة الفجر  
al fajer establishment

A MEMBER OF AL FAJER GROUP

www.fajerest.com







E-mail: [wellness@fajerest.ae](mailto:wellness@fajerest.ae)



مؤسسة الفجر  
al fajer establishment

A MEMBER OF AL FAJER GROUP

[www.fajerest.com](http://www.fajerest.com)

**Wellness** is a popular concept using natural therapies to actually improve physical health involving the management of our body state after the basic needs of food; shelter and basic medical care have already been met.

At **Al Fajer Establishment** Wellness Division, our goal is to pursue living life to its fullest potential involving two of the world's known brands like **SONAKI** and **RYN** products.

**SONAKI** invests in the research and utilization of our Natural Energy from earth elements like ceramic, water and air enhanced to its full benefits using E2 Technology (Electron Energized Technology), incorporated in all of its product lines to achieve a healthy balance of the mind and body resulting in over-all feeling of well-being.

**RYN** walking is proven to increase blood circulation, tones the body and burn more calories while walking as an exercise. Each shoes is ergonomically designed with a 45 degree angled outsole, and 7-layers insole giving you a foot-arch functional support to maintain good balance and posture while walking.

At **TENEVIS**, a Shoe list is a combination of Shoe and Specialist. They provide essential information based on each customer's body and feet conditions, to help them understand everything about their feet. Try our professional foot scanning service now. Go for a foot scan today!

**Taw & Toe** had developed the world's first (MDI) Multi Density Injection method to adhere the upper part of the shoe to the sole without any sort of gluing process, making it the human comfort shoe.



## Brands



TENEVIS





www.ubsin.com

**SONAKI** is a Korean word meaning shower, short passing rain. Sonaki cloud (shower cloud) is also called as cumulonimbus, and made by hot atmosphere on the ground surface that raises suddenly, that is 'sonaki' falls in order to cool the ground when it is too hot.

Unlike other kinds of rain, 'sonaki' is very momentary, energetic phenomenon. So people like fresh and cool nature, and they believe 'sonaki' is the source of powerful natural energy.

### E2 Technology:

E2 means these; Energy Embedding, Energy Encapsulation and Energy Encryption. That is, every material has its own atom, and an atom has electrons turning around the nuclear. Turning of electrons makes the energy field. By the wave power from E2 technology, this energy field can be controlled to the balanced, and enforced state.

### Products:

- Sonaki Air Purifier (Big size / Full size / Half Size / Mobile)
- Intelligent Cleaning Robot (iclebo)
- Sonaki Ion Cluster (Car Air Purifier)
- Sonaki Negative Ion Lamp
- Sonaki O<sub>2</sub>hi (Oxygen Generator)
- Sonaki Vitamin C Hand Shower
- Sonaki Sap Sheets
- Sonaki Magic Points
- Sonaki Bio Watch
- Sonaki Energy Rings
- Super Energy Rings
- Volcanic Rings



مؤسسة الفجر  
al fajer establishment

A MEMBER OF AL FAJER GROUP

www.fajerest.com



Established in 2006 with 150 employees at the time, RYN Korea geared up with US\$27m in capital and solid financial capability. A total turn-over of 27M in 2007 and in 2009 an estimated US\$80M sales turn-over from 160 shops in Korea alone.

In 2007 they started to expand to Europe, USA and parts of Asia and the Middle East. With its supply for department stores, orthopedic shoe stores, big sports shops, fitness shops and other retail outlets, RYN has come a long way to a growing business.

With its own factory in Busan, South Korea, RYN has invested in its R & D center in the field of functional footwear and was listed as #1 brand in KOSDAQ Awards in 2009.

Currently marketing worldwide thru TV and the internet, RYN Korea supplies to Eurosko, RYN Deutschland, Conway, Sanita, and Al Fajer Establishment in UAE and in the US.



Features of RYN walking posture  
Straight-back, Straight knee

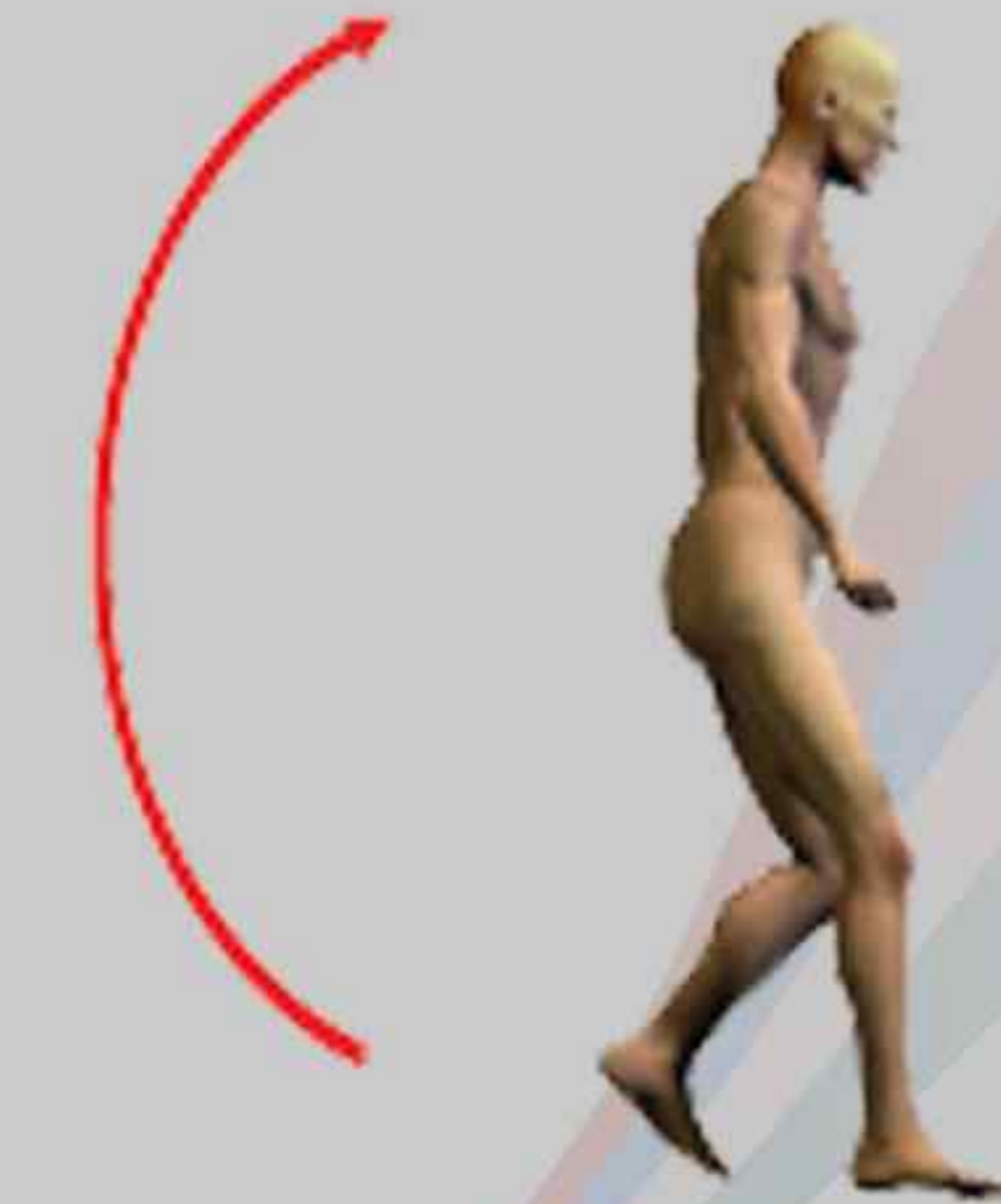

Features of Normal walking posture  
Bended back, bended knee



- Anti-Bacterial Fabric
- Shock-Absorption PU foam
- High ventilated EVA
- Molded shank
- Soft polyurethane
- Shock-Absorption tunnel
- Non-Slip rubber sole

**TENEVIS - SOFT AND POWERFUL SHOES!** Our walking and fitness shoes make walking effortless! Are you suffering from foot pain, back pain or knee pain? Do your feet hurt or do you have foot injuries? Are you living with heel pain, plantar fasciitis, bunions or heel spurs? Improve your foot health with TENEVIS - SOFT AND POWERFUL SHOES.

TENEVIS helps to relieve foot pain. TENEVIS sells the 1st & only FDA approved walking and body toning shoes, proven to strengthen the lower body, improve posture, & reduce impact. Start walking Soft & Powerful today with pain relief footwear from TENEVIS!

**Balance Chip**



**Balance Bone**



**AUTOMOBILE MECHANISM-TENEVIS**

We put automobile mechanism into shoes.



**TAW & TOE™**  
www.tawntoe.com

**HUMAN COMFORT SHOES TAW & TOE**

TAW & TOE is not merely a shoe, but more like a second skin, as you start a step with your toe, let's start the three S' of health ( Step, Sweat, and Smile) with TAW & TOE ( TAW means' start line')

TAW & TOE has been designed with the world's first technology MDI and produced with "DUFLEX" which is environmentally friendly material for optional walking pleasure with shock absorption flexibility, and ultra light weight.

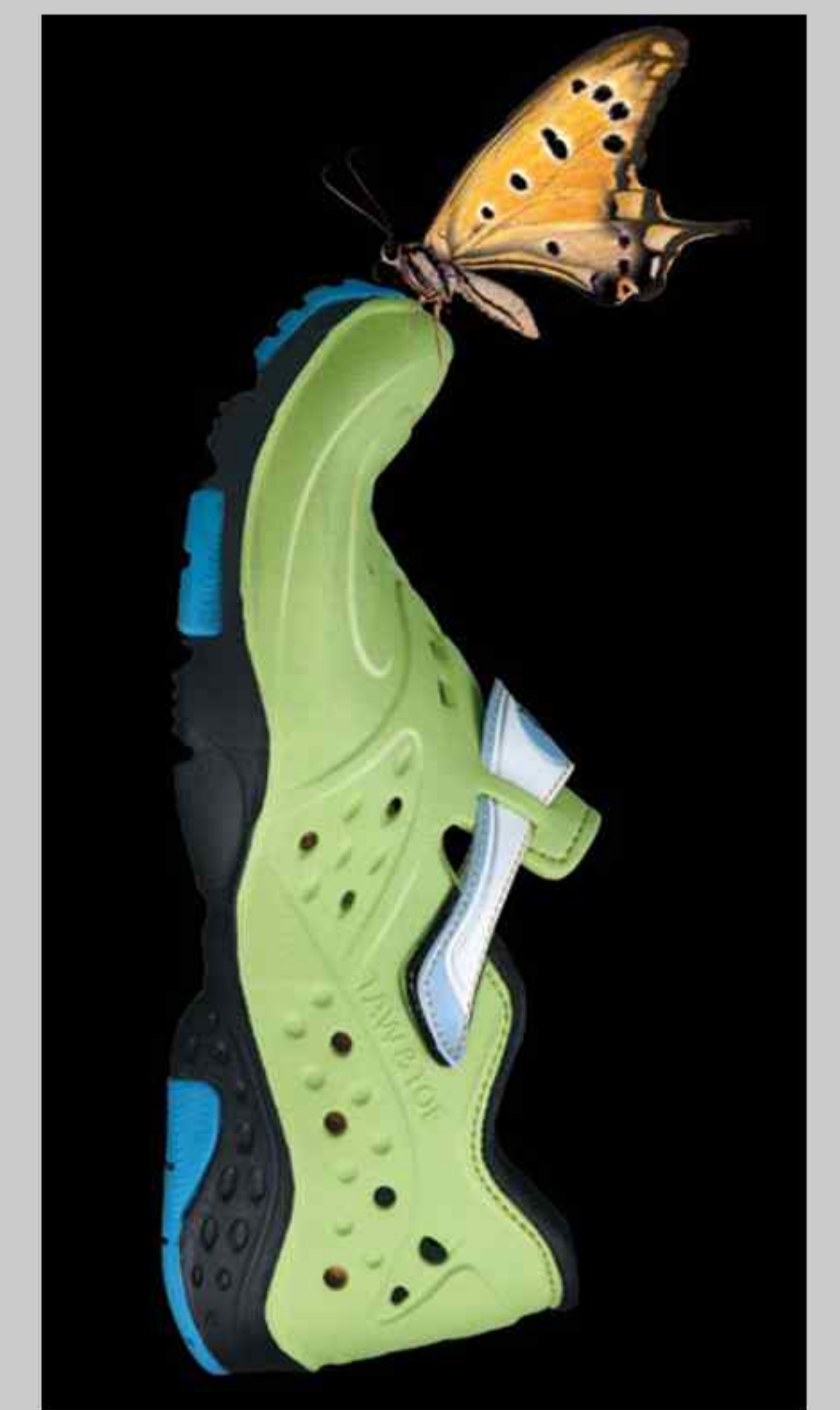

The **CHM Division** of **Al Fajer Establishment** becomes one of the distinct names in the field of Consumer as serving UAE in Quality.

We represent some of the world class brands namely **Caroli & Pely**, Germany.

In the field of consumer products, **Caroli & Pely** has been associated with quality, performance and innovation. They recognized that a product was most likely to succeed if it was carefully designed to meet identified consumer needs.



## Brands

**Caroli**  
Soft, Comfortable & Safe  
Sanitary Towels

**Pely**<sup>®</sup> clean

The extensive Caroli Premium cotton wool range for hygiene and beauty care ranges from pleated cotton wool and cotton wool balls to cotton buds and moist and dry duo cotton wool pads with aloe Vera and other valuable ingredients.

This will give you Always best protection plus an extra silky softness. Feel completely protected with the silky lightness.

Caroli Ultra Sanitary Towels, ultra soft, skin-friendly surface, ultra thin absorbent core, the fluid is locked in the core for maximum comfort.



**Pely** clean

Pely helps around the house with a wide range of tried-and-tested and innovative products that make everyday life easier. Using high-quality raw materials, we offer freezer and ice-cube bags, cling film and aluminum foil, as well as greaseproof paper bags, sandwich wrap and pre-cut baking paper that fits baking trays perfectly.

Pely garbage bags with drawstrings for the waste generated in the kitchen, home and garden. A specialty for the convenient and hygienic disposal of biodegradable household refuse are our environmentally friendly garbage bags made of paper or guaranteed biodegradable





Al Fajer Establishment is proud to be associated with FogScreen Company that has changed the projection technology forever and Cedar Electronics, manufacturer of Indoor & Outdoor LED Screens.

Our Event Equipments Division strive to deliver a high standard of quality and value for money to our customers. We work in close partnership with our customers to offer a service that sets new standards in event management, with our customers needs always at the forefront of our mind.

FogScreen is a rear projection screen (the projector or light source is behind the screen). FogScreen projection screen is used so often at product launches, trade shows, restaurants, nightclubs, museums, and other venues.

Cedar Electronics offers Full color LED display products that have been applied all over China and other countries such as USA, Canada, UAE, Russia, Germany, Japan, etc.



مؤسسة الفجر  
al fajer establishment  
A MEMBER OF AL FAJER GROUP  
www.fajerest.com



## Brands

FOGSCREEN™  
walk through magic

Cedar Electronics  
Indoor & Outdoor LED Screens

**FOGSCREEN™**  
walk through magic  
[www.fogscreen.com](http://www.fogscreen.com)

FogScreen company changed projection technology forever – no more fixed screens. Our breakthrough product, the FogScreen® projection screen, produces a thin curtain of “dry” fog that serves as a translucent projection screen, displaying images that literally float in the air. The result: stunning, attention-demanding displays with unlimited application possibilities!

**CONCEPT:** It's as simple as it is stunning. Using nothing more than tap water and ultrasonic waves, FogScreen projection screen machine employ a patented technology to create a smooth foggy airflow that captures images just like a screen. You can walk right through a FogScreen projection screen without getting wet. The macroscopic fog droplets actually feel dry to the touch, just like air.



 **Cedar Electronics**  
Indoor & Outdoor LED Screens  
[www.ccxida.com](http://www.ccxida.com)

Changchun Cedar Electronics Technology Co., LTD., a leading Chinese professional LED display panel manufacturer, is a high-tech enterprise whose master shareholder is Changchun Institute of Optics Fine Mechanics and Physics under CAS. Cedar integrates research, development, production, marketing and graduate education as one entity. It has been certificated by CCC and CE.

In order to guarantee the quality of our products, we have introduced advanced production and testing facilities. With efforts of all these years, we have become the leader of LED display industry in China in production management, quality control and production efficiency.



مؤسسة الفجر  
**al fajer establishment**

A MEMBER OF AL FAJER GROUP

[www.fajerest.com](http://www.fajerest.com)



Outdoor Advertising LED Display Panels





Al Fajer Enterprises  
(A HOLDING Co.)

## OUR ASSOCIATE COMPANIES

### ★ Construction :



### ★ Industry :



### ★ Trading :

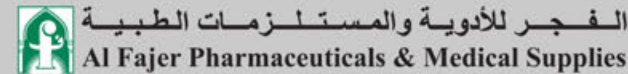

### ★ Services :





مؤسسة الفجر  
al fajer establishment

A MEMBER OF AL FAJER GROUP

www.fajerest.com

## OUR GLOBAL PARTNERS



For Every Use There Is A Solution





مؤسسة الفجر  
al fajer establishment  
A MEMBER OF AL FAJER GROUP  
www.fajerest.com

## OUR GLOBAL REACH





Back 



know more



DUBAI:  
P.O.Box: 1600, Dubai - U.A.E.  
Tel.: (04) 333 2985  
Fax: (04) 333 2981

ABU DHABI:  
P.O.Box: 2752, Abu Dhabi - U.A.E.  
Tel.: (02) 552 0007  
Fax: (02) 551 3544

Qatar Office:  
Tel.: +974 44 325 662  
Fax: +974 44 325 643  
P.O.Box: 80859, Doha - Qatar

 /fajerest  
E-mail: [info@fajerest.ae](mailto:info@fajerest.ae)  
Website: [www.fajerest.com](http://www.fajerest.com)