

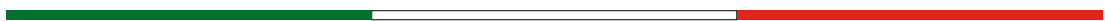

M A D E I N I T A L Y





# WHO WE ARE



Xport Group is an acknowledged and ambitious leader who focuses on marketing and trading in the wide-ranging field of construction, building and fit outs supplies.

For over two decades we have been connecting, improving and empowering the rapidly growing and sophisticated demands of the Middle East (ME) and GCC to the European products and manufacturing entities. We have taken part to the accomplishment of the architectural icons of the region.

Headquartered in Dubai. Which is the perfect Hub to embrace the ME and the entire Arabian Peninsula to the worldwide-recognized EU Quality Standards. Our extensive portfolio specifically showcases the celebrated "Made in Italy" that is well known for its unique Design and Creativity. We represent over 1 billion euro of the total TO of the Made in Italy in the region.

Our multicultural origins along with our established presence in the Middle East and in the GCC, gave us the chance to be at the right place at the right moment.

We fulfil the requests of the most demanding architects, developers and contractors in the GCC (UAE, Saudi Arabia, Qatar, Kuwait Oman and Bahrain) and all over the ME.

To the most innovative requests, we never failed to provide multiple original solutions, smart designs and exclusive EU standard certified quality products matched by the necessary local pre-qualification in order to be effective and operational on the spot.

Throughout the ME and GCC we are perceived with trust and reliance that we never failed to validate and strengthened over the years.

# MISSION & VISION

Our business approach is sharply marketing oriented. We target to identify the most innovative architectural trends and satisfy the challenging needs and calibres of local consultants, developers and architects throughout a wide geographical area with different and similar cultural features as the Middle East and GCC.

We represent exclusively EU certified companies with proven worldwide references.

All our products of all different categories are ready to be used on regional projects having been previously pre-qualified by local authorities and therefore easily locally accessible from the constructors.

Our personnel, a group of multicultural professionals engineers Italian-English-Arabic speaking, are able to give a fair and clear picture of the wide and prosperous market in which we are operating and a "tailor made "proposal from our "Made in Italy" partners.

Our team performs as a real "trade-union" between our Italian partners, their product development department and the demanding reality of the region in terms of safety, quality and design.

# STRATEGY



Our marketing strategy of horizontal trading entity combines all its marketing goals into one comprehensive plan.

We strongly believe a good marketing strategy should be drawn from a keen market research to grasp the most innovative and newest trends from the Made in Italy, empower our range to make it wider and wider to fulfil the ambitious development plans of the region.

Thanks to our well-monitored and locally spread strategy, we are proud to state that we have been delivering our promises to our partners for over 20 years.

Our Marketing research counts on a solid and proven "data base" of contacts and data collection from our partners and our team along with the ever changing market trends monitoring and advancing how they are shifting to.

We have been partners of the most ambitious projects and landmarks in UAE, GCC and Middle East, both private and public, supplying original Designs and the most advanced fit outs.

# OUR REFERENCES DEVELOPERS



# OUR REFERENCE CONSULTANTS

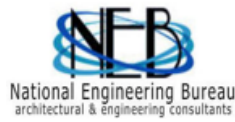

# OUR REFERENCES CLIENTS



مركز الغرير  
AL GHURAIR CENTRE

جودة مدى الحياة







PASSION AT WORK



AL HANI CONSTRUCTION & TRADING CO.  
شركة الهاني للإنشاءات وا



ROSEWOOD HOTEL®



Specialized Investment Group





PROJECT REF.	LOCATION	YEAR	PRODUCT
Rosewood Hotel	Jeddah, Saudi Arabia	2005	Doors
Intercontinental Hotel	Khobar, Saudi Arabia	2005	Doors
Movenpick Tower & Suites Hotel	Dafna – Doha, Qatar	2006	Doors
2 Residential Buildings for, Doha	Sadd – Doha, Qatar	2006	Doors
Residential Building @ Marina	Dubai, UAE	2007	Doors
Jumeirah Business Centre Towers	Dubai, UAE	2009	Doors
Qatar Tower Office Building	Dafna - Doha, Qatar	2010	Doors
30 villas compound & 41 Villas Compound	Al Rayyan – Doha, Qatar	2010	Doors
The Mangrove Place	Reem Island, Abu Dhabi-UAE	2012	Doors
Al Ghanim Apartments	Old Ghanim-Doha.Qatat	2012	Doors
Al Ghanim Offices	Old Ghanim-Doha, Qatar	2012	Doors
Filatex - Two Residential Building in Madagascar	Madagascar	2012	Doors
Private Penthouse (Jumeirah Beach Residence)	Dubai, UAE	2015	Doors
Virginia Commonwealth University	Doha, Qatar	2008	Acoustic Insolation
North Western University Studio	Doha, Qatar	2008	Acoustic Insolation
United Towers	Kuwait	2009	Acoustic Insolation
Sharjah Education Council Building & Multipurpose Halls	Sharjah, UAE	2009	Acoustic Insolation
Virginia Commonwealth University	Doha, Qatar	2009	Acoustic Insolation
Al Wajbah Majlis	Doha, Qatar	2009	Acoustic Insolation
Al Khour Sports Club	Doha, Qatar	2010	Acoustic Insolation
Carolina Building	Amwaj Islands, Bahrain	2010	Acoustic Insolation
Traditional Theatre at Grand Hammad	Doha, Qatar	2010	Acoustic Insolation
Residential Building in Amwaj Islands	Bahrain	2011	Acoustic Insolation
Al Jalila Children Hospital	Dubai, UAE	2012	Acoustic Insolation
Caramel Restaurant & Lounge,	Saadiyat Island, Abu Dhabi-UAE	2013	Acoustic Insolation
BOA Steakhouse	Eastern Mangrove, Abu Dhabi-UAE	2013	Acoustic Insolation
Hamad International Airport (Doha Airport)	Doha, Qatar	2013	Acoustic Insolation
Ajman Independent Studios	Ajman, UAE	2013	Acoustic Insolation
Ibis / Novotel Hotel	Tehran, Iran	2014	Acoustic Insolation
Kidzania	Kuwait	2014	Acoustic Insolation
New Navy Headquarters	Lahore Pakistan	2014	Acoustic Insolation
Al Wathba Al Nahda School Auditorium	Abu Dhabi, UAE	2014	Acoustic Insolation
Holiday Inn (Nightclub/VIP Lounge)	Embassy District, Dubai	2014	Acoustic Insolation
Limestone House Ritz Carlton	Dubai, UAE	2014	Acoustic Insolation
IKIA Hotel	Tehran,Iran	2014	Acoustic Insolation
Pakistan Navy headquarters	Pakistan	2014	Acoustic Insolation
Community Welfare Hospital Ruwais	Dubai, UAE	2014	Acoustic Insolation

PROJECT REF.	LOCATION	YEAR	PRODUCT
Qamardeen Hotel	Dubai, UAE	2012	Vertical extension walls & Roof
AMS-KMV VIP Villa	Abu Dhabi, UAE	2012	Wall finishes
Al Thani VIP Villa	Dubai, UAE	2013	Flooring
Emaar Boulevard	Dubai, UAE	2014	Cladding
Sharjah Business Center	Sharjah, UAE	2014	Cladding
Bay Central East Tower	Dubai, UAE	2014	Cladding
Inhabit new office	Dubai, UAE	2014	Flooring
Obegi Furniture Showroom	Jumierah, Dubai, UAE	2014	Walls
Al Gurair Shopping Center	Dubai, UAE	2014	Walls
Mall of Emirates	Dubai, UAE	2014	Flooring
The Gallery	Saudi Arabia	2014	Walls
Makeup Forever Shop	Saudi Arabia	2014	Flooring
Truffle Moi Boutique Office	Dubai, UAE	2014	Flooring
Matrix Tower	Sport City, Dubai-UAE	2013	Aluminium Expanded Metal Mesh
The Yas Mall	Yas Mall At Yas Island, Abu Dhabi	2013	Aluminium Expanded Metal Mesh
The Dubai Creek Cloud	Dubai Golf Club	2013	Aluminium Expanded Metal Mesh
Anantara Project	Doha, Qatar	2013	Aluminium Expanded Metal Mesh
Roberto's Restaurant	Dubai, UAE	2013	Aluminium Expanded Metal Mesh
Yas Island (ALDAR)	Abu Dhabi, Abu Dhabi	2013	Substation Cladding
Fertilizer Plant Project	Nigeria	2014	Aluminium Expanded Metal Mesh
Kuwait Municipality	Kuwait	2014	Modern Lamp Post and Urban Furniture
Dammam Municipality	Dammam, Saudi Arabia	2012	Modern Lamp Posts
Al Hassa Municipality	Al Hassa, Saudi Arabia	2012	Modern Lamp Posts
Jumeirah Beach Residence	Dubai, UAE	2012	Gazebos
Jumeirah Beach Residence	Dubai, UAE	2012	Bus Shelter
Jumeirah Beach Residence	Dubai, UAE	2014	Traditional Lamp Posts
Al Khobar Municipality	Al Khobar, Saudi Arabia	2014	Modern Lamp Posts
Dubai Municipality	Dubai, UAE	2005	Automatic Smart Public Toilet
Abu Dhabi Municipality	Abu Dhabi UAE	2008	Automatic Smart Public Toilet
Doha Municipality	Doha, Qatar	2012	Automatic Smart Public Toilet
Al Ain Municipality	Al Ain, UAE	2012	Automatic Smart Public Toilet
Dammam Municipality	Dammam, Saudi Arabia	2015	Automatic Smart Public Toilet
Arbian Ethicals Co.	Dubai, UAE	2012	Hospital Equipment
Badawat Medical Establishment	Dubai, UAE	2012	Hospital Equipment
Gulf and World Traders	Dubai, UAE	2012	Hospital Equipment
Meadows Villa	Dubai, UAE	2008	Fly's Screen
Spring villas	Dubai, UAE	2008	Fly's Screen
Emirates Hills	Dubai, UAE	2010	Fly's Screen
Al Barari villas	Dubai, UAE	2012	Fly's Screen
Saadiyat Villas	Abu Dhabi, UAE	2013	Fly's Screen

# CATEGORIES



**1** | WOODEN DOORS  
(FIRE & NON-FIRE RATED)

P. 15-63



**2** | KITCHEN CABINETS  
& WARDROBES

P. 65-85



**3** | BATHROOMS  
& SANITARY FURNITURE SOLUTIONS

P. 87-107



**4** | ACOUSTIC INSULATION

P. 109-123



**5** | CLADDING: COVERING & FLOORS

P. 125-169



**6** | EXPANDED METAL SHEETS  
& STAINLESS STEEL WIRE MESH

P. 171-215



**7** | URBAN LIGHTENING  
& STREET FURNITURE

P. 217-277



**8** | AUTOMATIC SMART PUBLIC TOILETS

P. 279-307



**9** | FENCING SOLUTIONS

P. 309-317



**10** | REVOLVING FLY SCREEN

P. 319-331



**11** | BLINDS & PERGOLAS

P. 333-349



**12** | VIP HOSPITAL FURNITURE  
SOLUTIONS

P. 351-359

M A D E I N I T A L Y



CORONA



POLARIS



PULSAR







PULSAR

EPSILON





POLARIS

POLARIS

LINEAR





The image shows two white doors set against a light grey wall. The door on the left is closed and features a simple, horizontal silver handle. The door on the right is open, revealing a glimpse into another room with wooden cabinetry and shelves. The floor is made of light-colored wood. The word 'FILO' is printed in a clean, white, sans-serif font between the two doors.

FILO

ALFA V



QUASAR L



LINEAR GHOST



CASSONETTO MINIMA





EPSILON SCORREVOLE







QUASAR L

A modern hallway with a red door and a staircase. The door is dark red with a silver handle and is set in a dark wood frame. To the right, a staircase with dark wood steps and a metal railing is visible. The walls are white, and the floor is dark grey. A light fixture is visible on the ceiling.

MADRAS

MYSORE VETRO



PAKORA



PAKORA





ANDROMEDA

DAFNE





URANIA

MANIGLIA ROBOT







INGRESSO BLINDATO PLUTONE

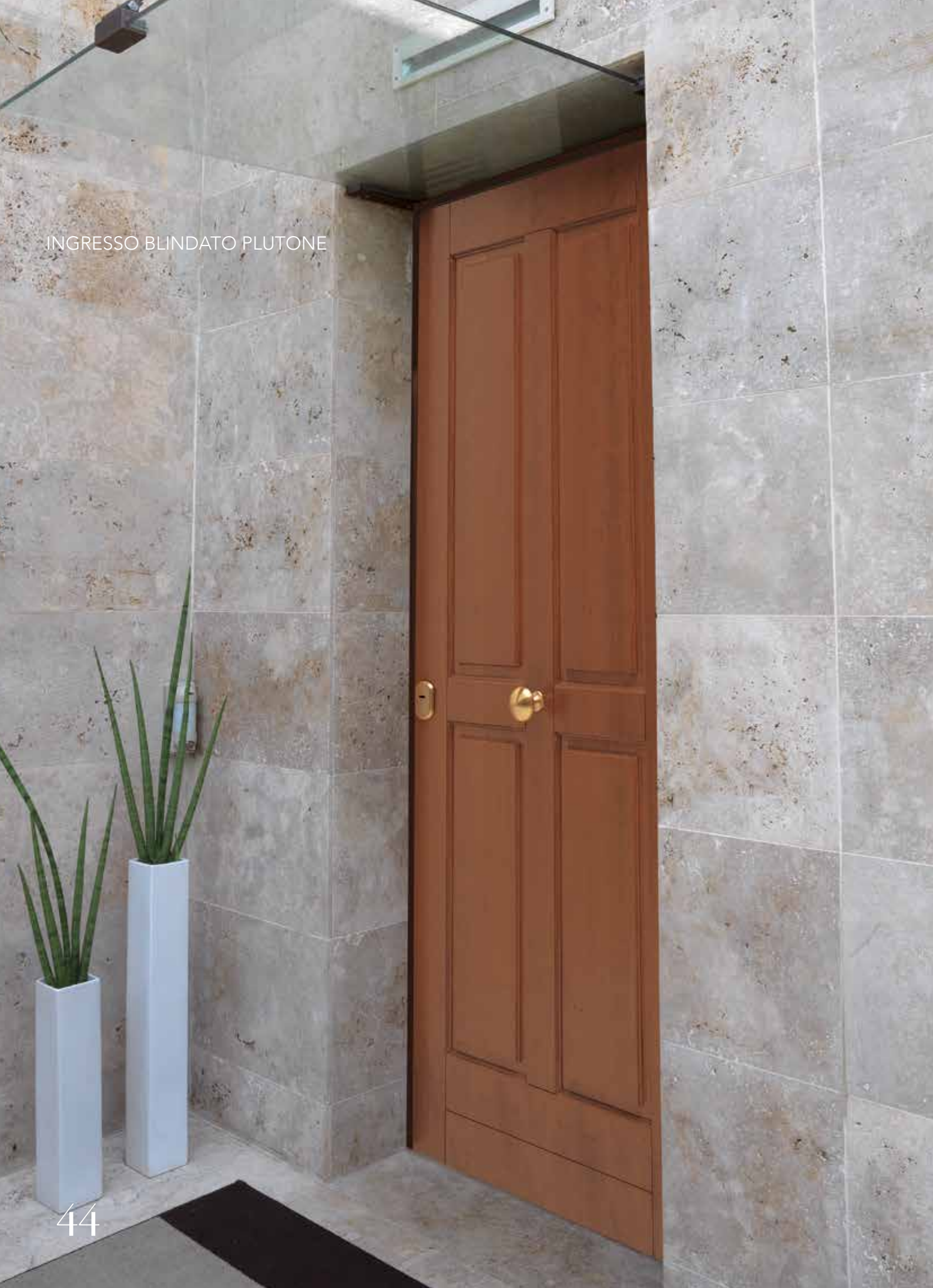





INGRESSO BLINDATO BUGNATO 6





INGRESSO BLINDATO DELTA

INGRESSO BLINDATO EUROPA



231

232



PLANA/BOIS DOOR VERSION





BOIS DOOR



PLANA







LINEA CAPITELLI

NEW YORK



A photograph of a white door with a silver handle and lock, set in a modern interior. The door is framed by a white border. To the right, a glass table and a chair are visible, suggesting a dining or kitchen area. The background wall is a light, textured grey.

HALLEY

DOGE VETRO





DIPLOMAT

VICTORIA





CORALLO



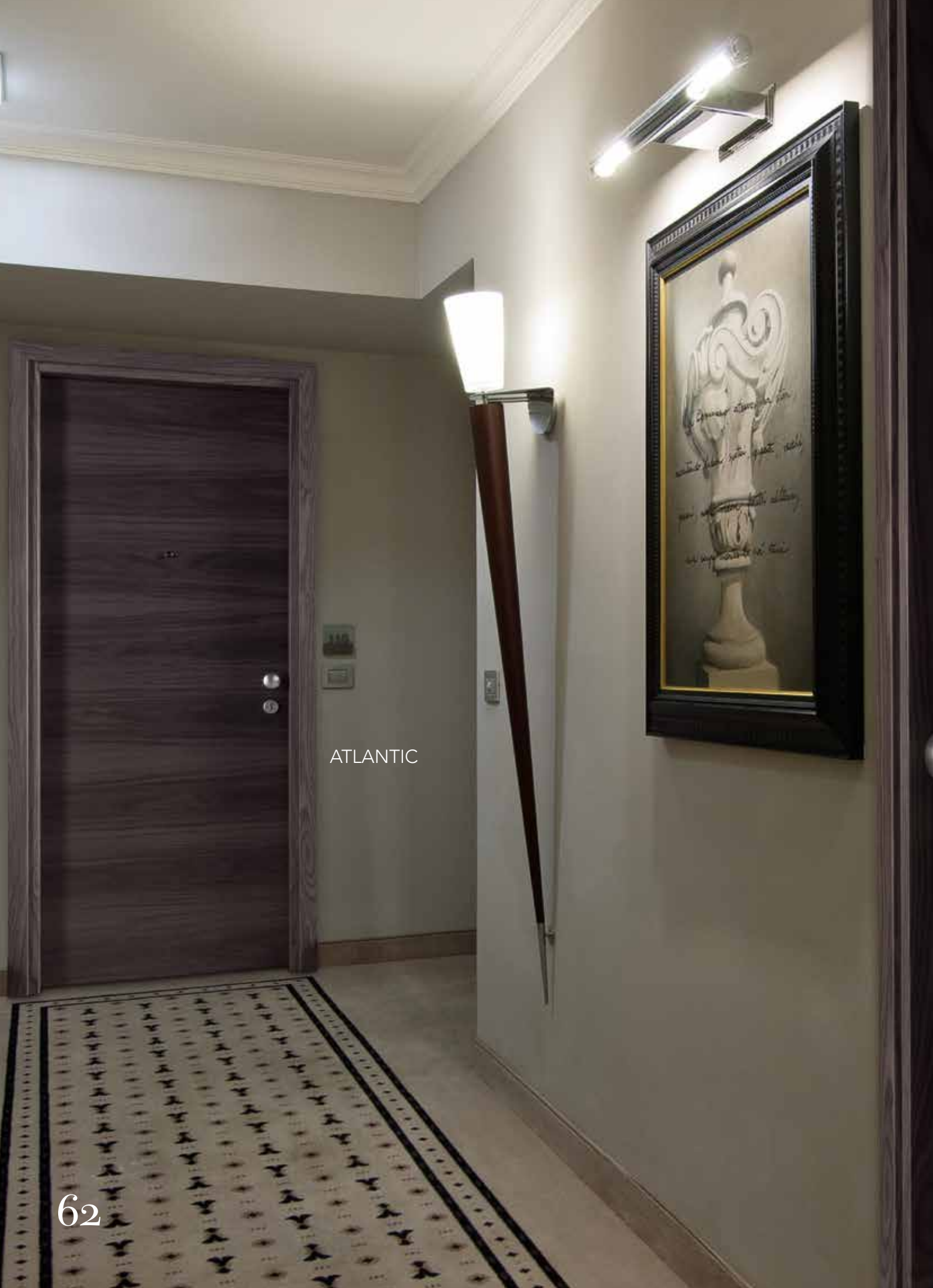

ATLANTIC



DIAMANTE

M A D E I N I T A L Y









































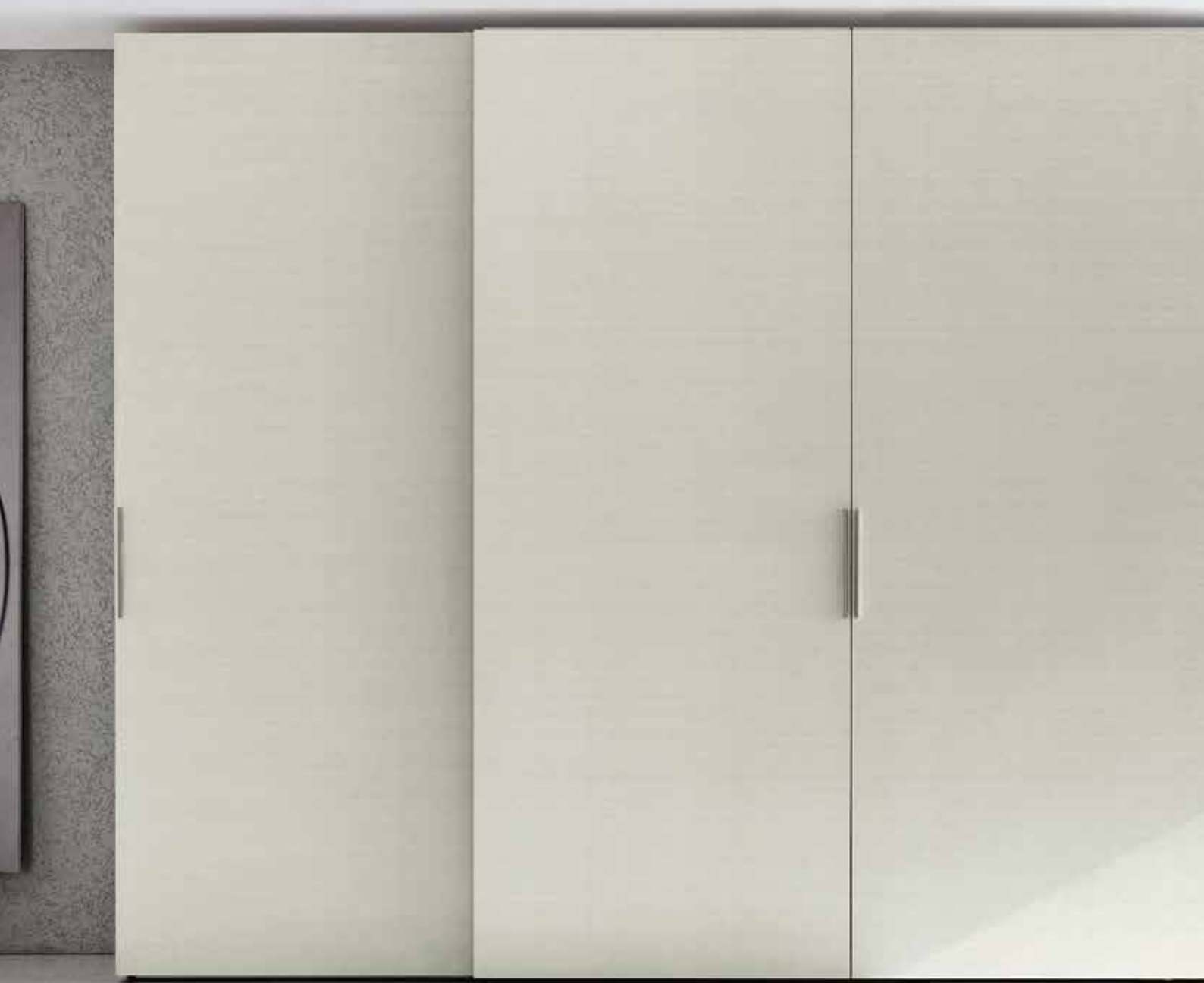





M A D E I N I T A L Y





 **bertani**  
I T A L Y

## BERTANI S.p.A. MILESTONES

**1916** The business opened under the name Bertani Amedeo as a small shop in the centre of Reggio Emilia that retailed sanitary products.

**1916-1967** The business's ownership passed down to the founder's heirs and it expanded, moved its headquarters and changed its name to Bertani s.n.c.

**1981** The first small showroom was opened.

**1989** Moved to 5,000 sqm surface current Head Quarter.

**1994** The first branch was opened in Parma.

**1996** The new showroom was built near the Headquarters.  
Bertani became a Joint-Stock Company.  
Its second branch opened in Modena.  
The Intesa Srl Company was founded with 5 other retailers of sanitary and heating materials active in different parts of northern Italy.

**1999** The company was certified ISO 9002 Quality System by DET NORSKE VERITAS. Later in 2005 the certification was extended to the ISO 9001/2000 standard.

**2000-2009** New branches opened: Sassuolo-Mirandola-Sardinia-Pavullo-Fidenza-Alghero-Calerno and Viadana.  
Bertani S.p.A. wins the best showroom Award 2009 during a ceremony at Cersaie in the class "Best Service to Customers".

**2010** Bertani S.p.A. gets SOA certification- Statement of qualification for execution of public contracts-Category 06 Class III.  
First POS outside Italy: Bertani London Ltd.

**2011** Bertani S.p.A. opens up Online Sales in Italy, Switzerland, Germany, Spain, Eastern Europe and Taiwan.

**2012** Bertani S.p.A. opens in UAE through Xport Group its Marketing Middle East branch in Dubai.

**2014** First Showroom in Abu Dhabi.

**2015** Bertani's expansion in the GCC is testified by a new opening in Doha-Qatar.



DUBAI

Marketing Office  
Arjaan Tower - Office 805  
Dubai Media City  
P.O. Box 502396 Dubai - UAE  
T +971 4 4347172  
F +971 4 4343040

ABU DHABI

Showroom  
Arabian Gulf Tower - Tourist Club St  
P.O. Box 30428 Abu Dhabi - UAE  
T +971 2 6778803  
F +971 2 6778834

DOHA

Showroom  
D-Ring Road - Villa 180  
Nuaija 41  
Doha - Qatar

 bertani

 agape

antoniolupi



Devon&Devon

MO  
AB  
80

NEUTRA

IDEA

AQUA

DISENIA

BLOB

 DURAVIT

→ FLAMINIA.

ZUCCHETTI.

KOS

teuco



effegibi

KALDEWEI

cea

 FANTINI  
RUBINETTI

ABOUTWATER

GESSI

DORN  
BRACHT

 Rapsel

vola





baden masters

TUBES

nutal



NIC Design

GLOBO

GALASSIA





ARTCERAM

LAUFEN

Roca



calibe

REGIA





OML















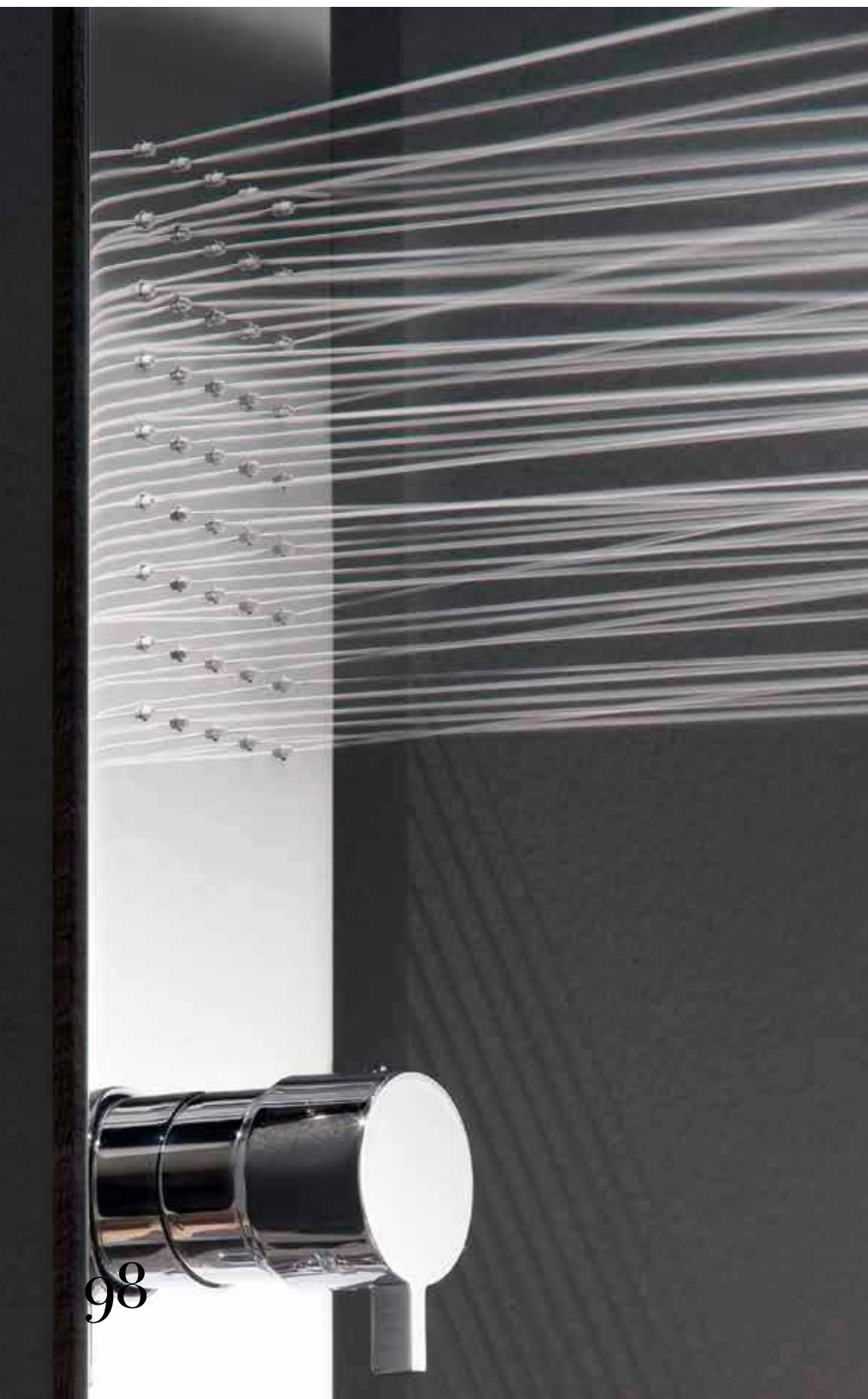







 bertani







IO4

 bertani

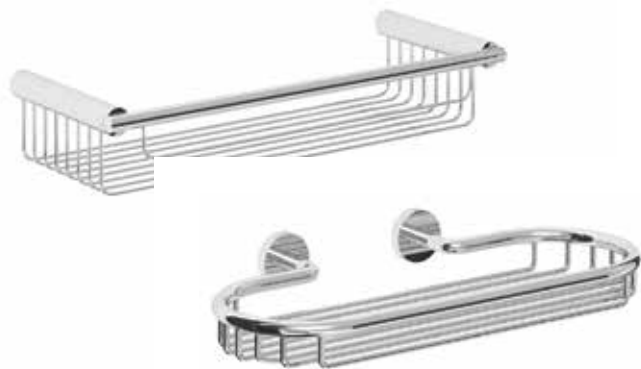

105



106

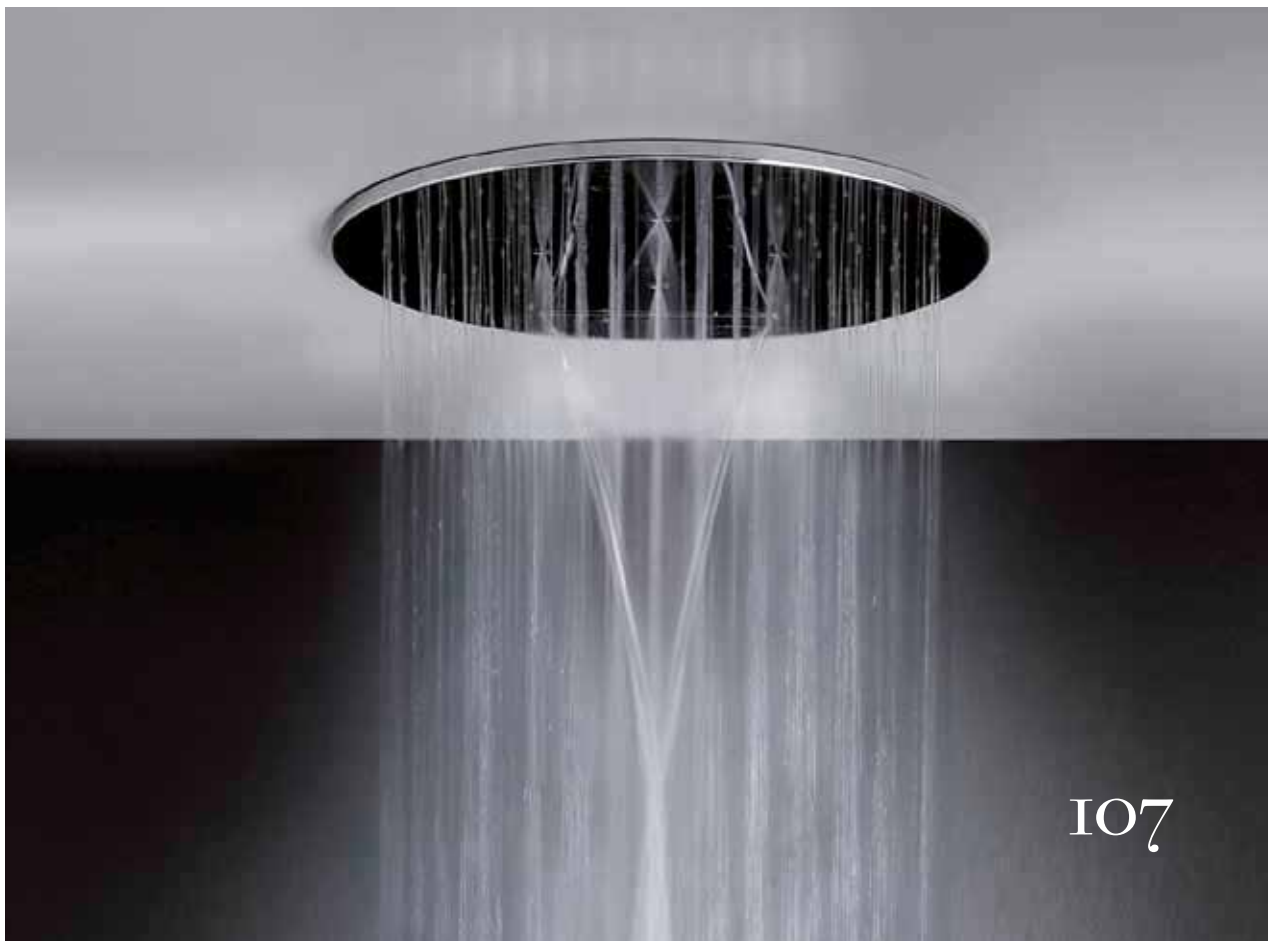

M A D E I N I T A L Y



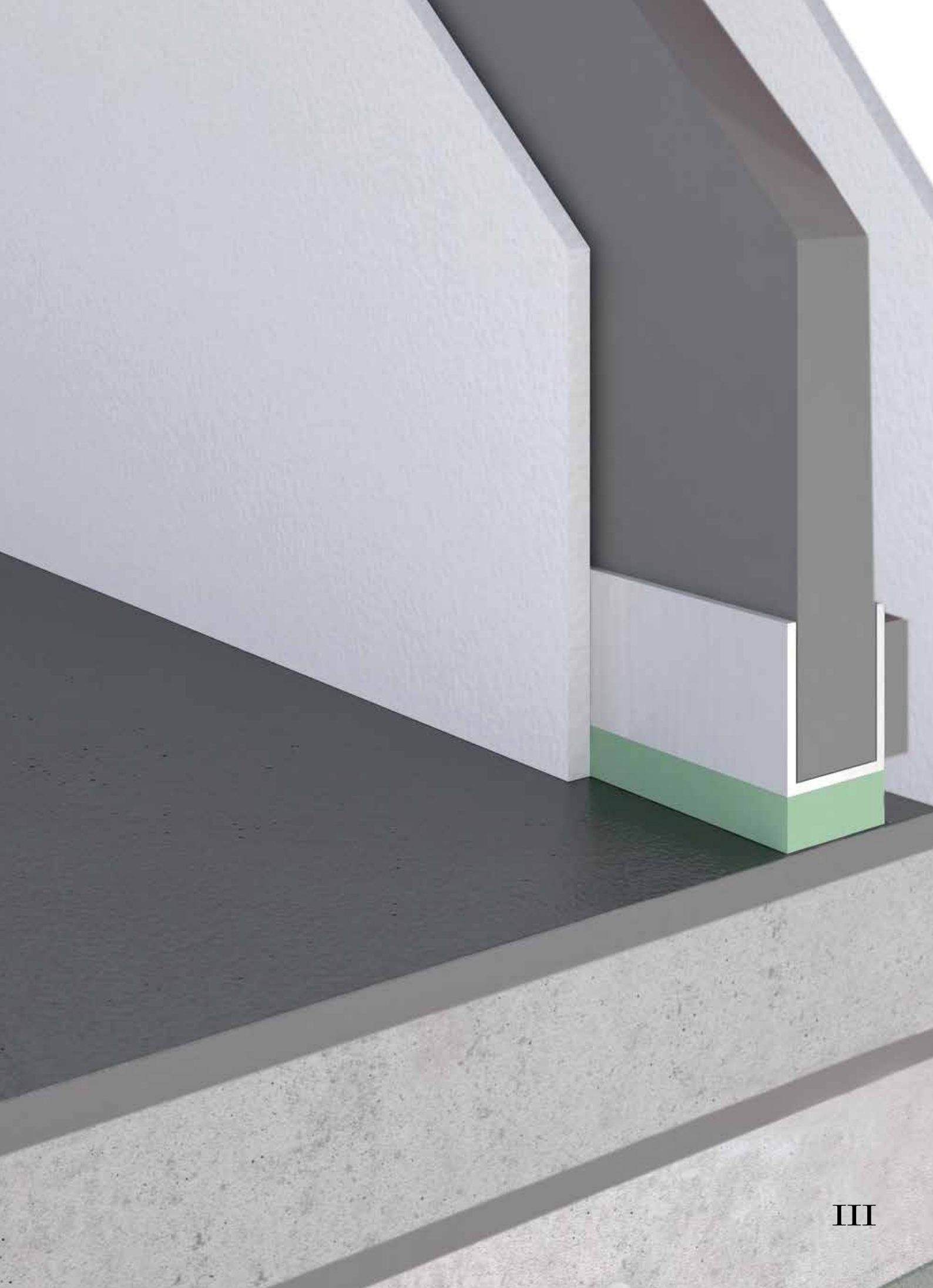

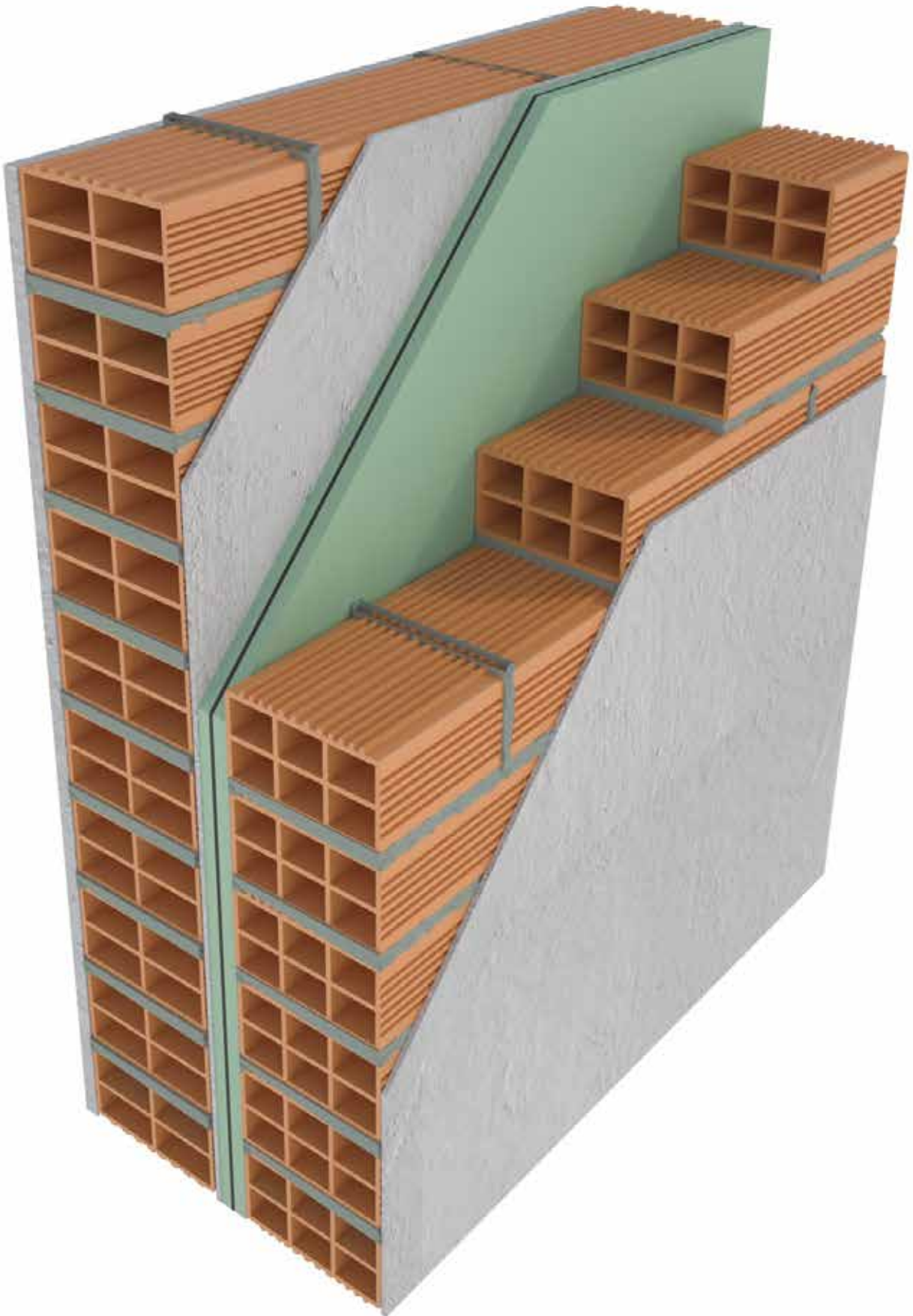





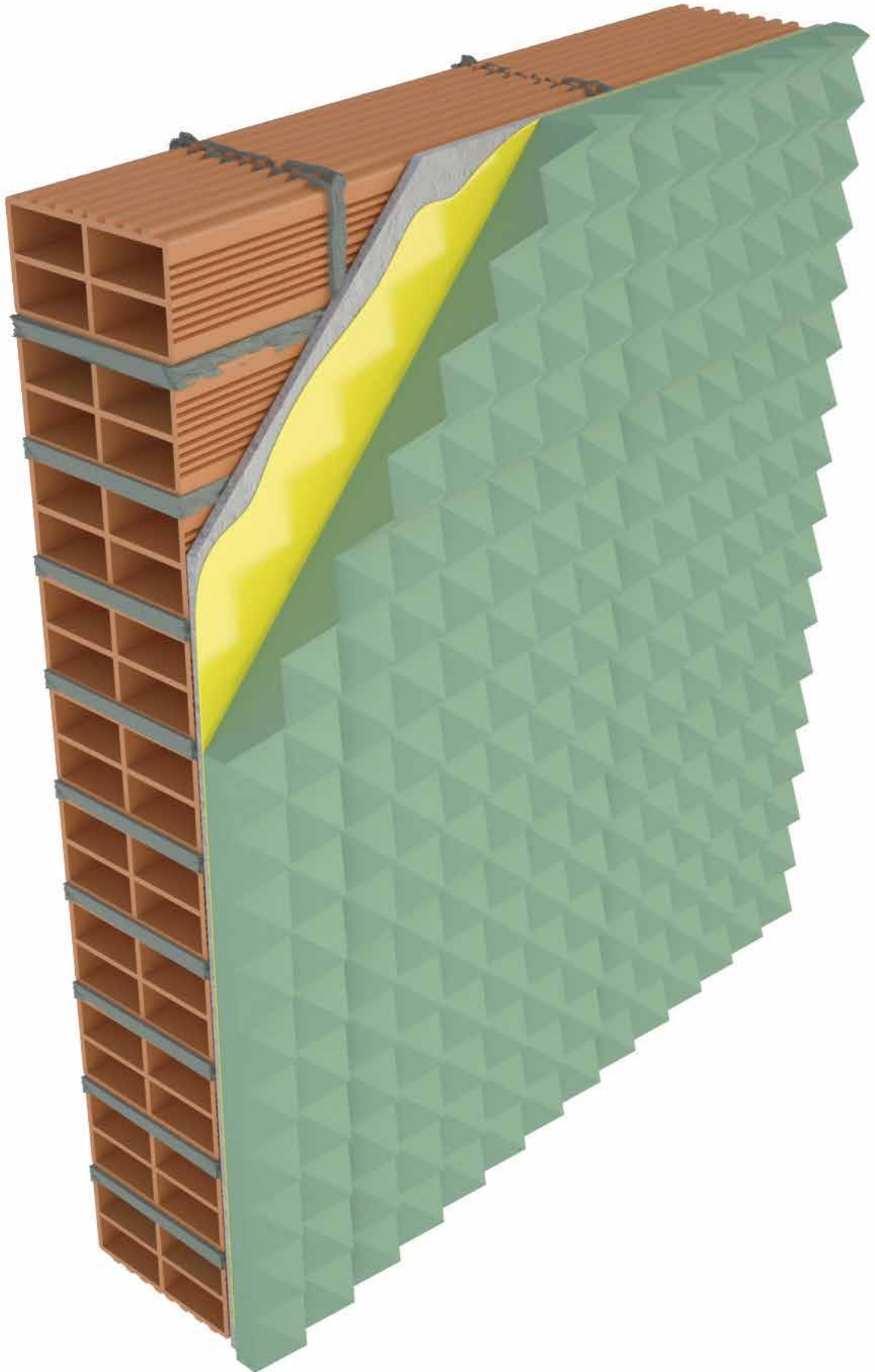

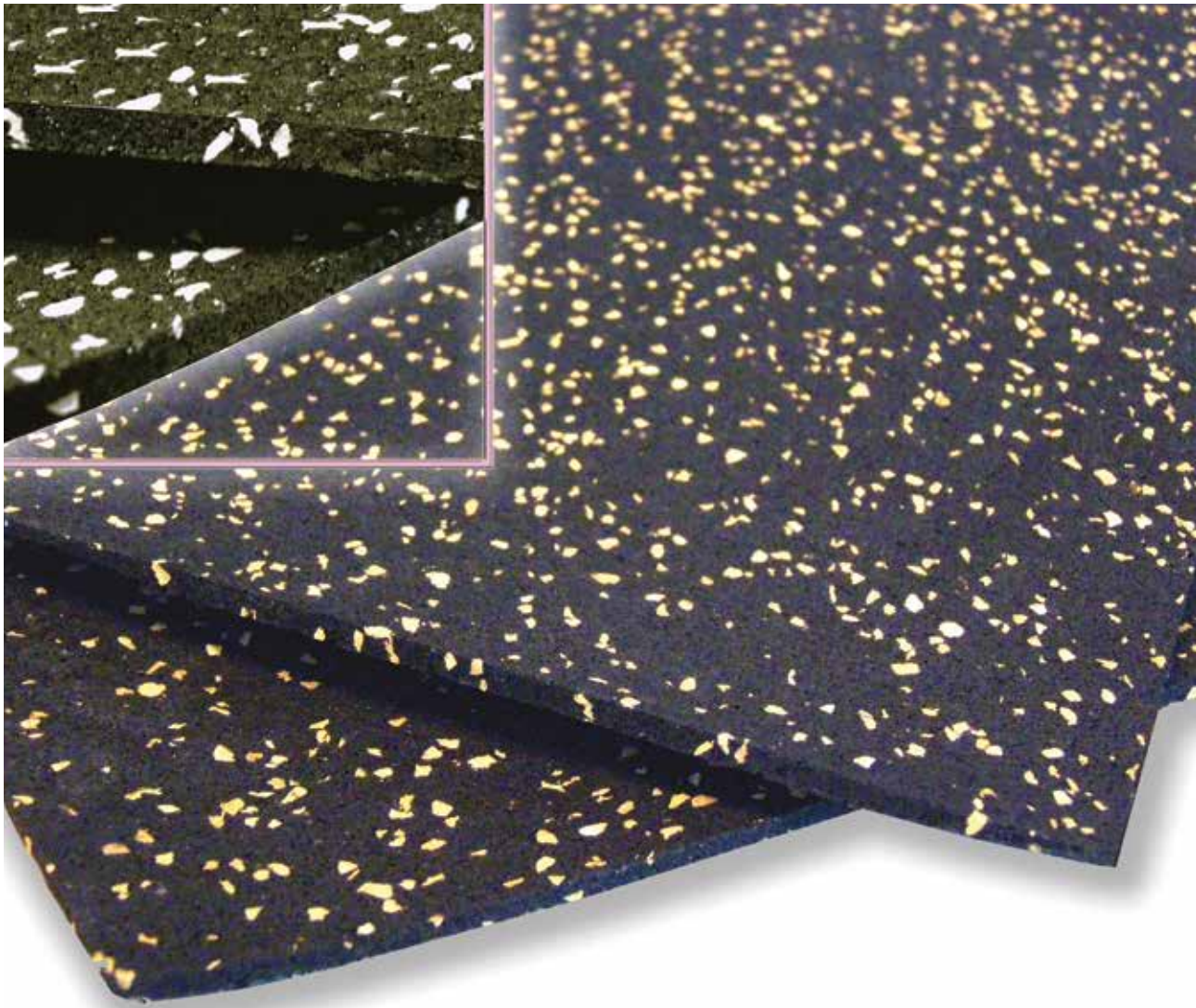
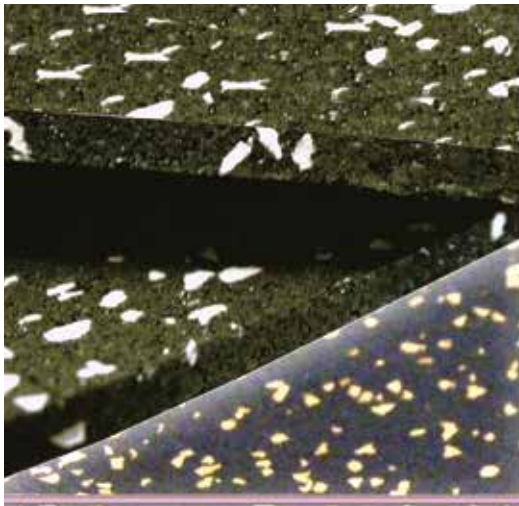
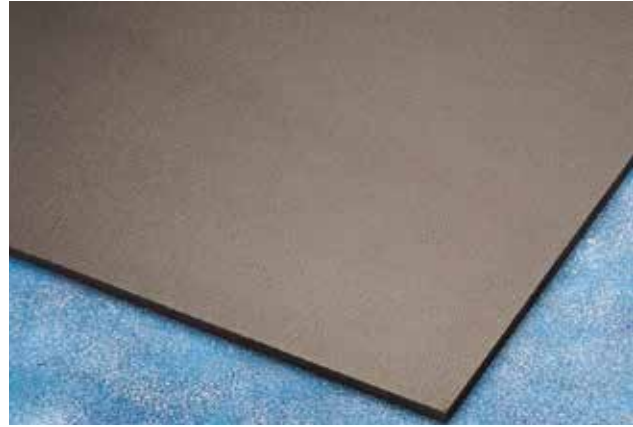
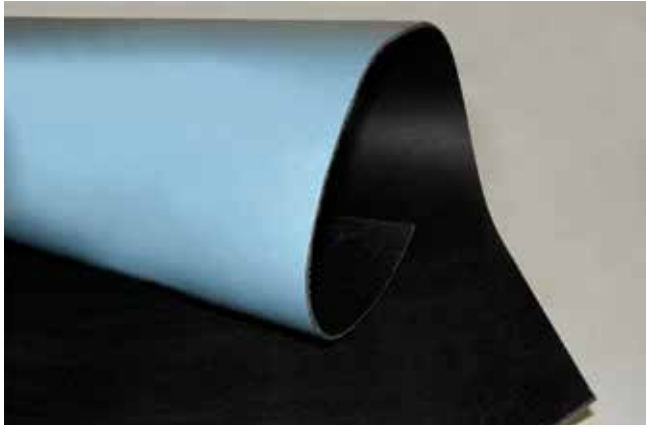



ITALY





AL JALILA HOSPITAL - UNITED ARAB EMIRATES













M A D E I N I T A L Y





LAMINIA ®

# BLEND

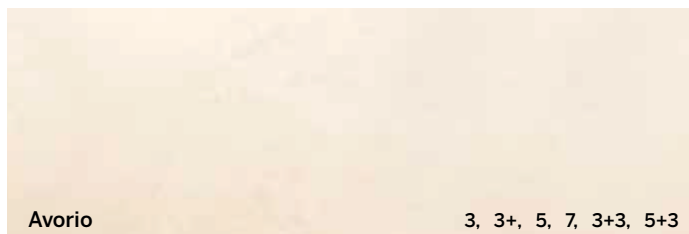

## COLLECTION LUCIDATO

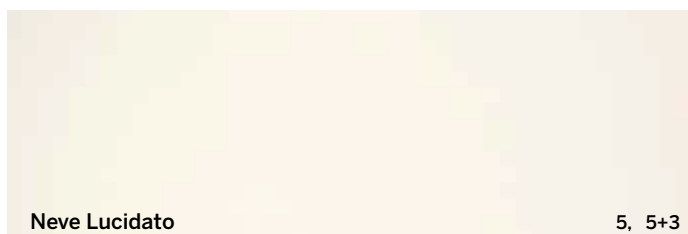
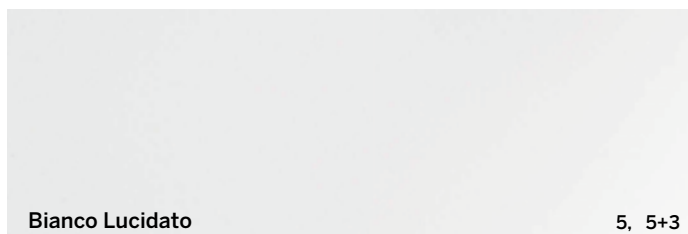

# FILO

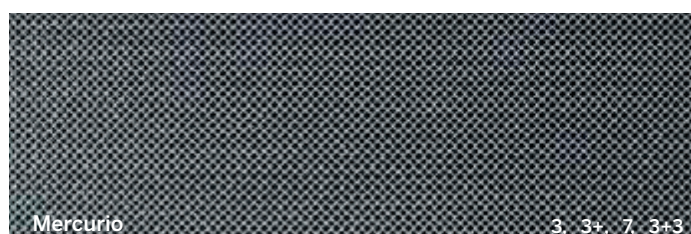
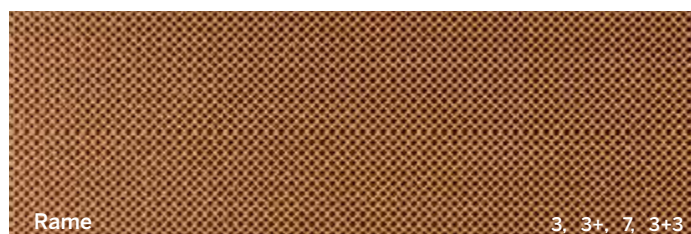
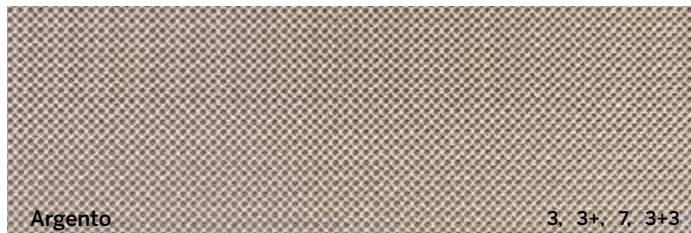



# FOKOS

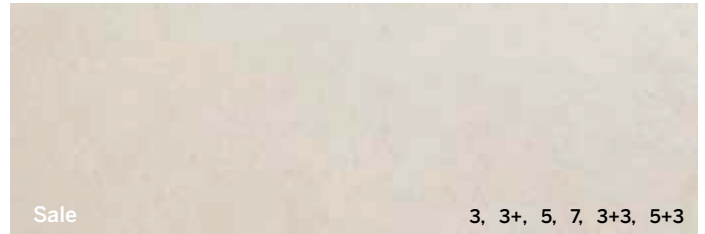

## I METALLI



# I NATURALI\_ PIETRE

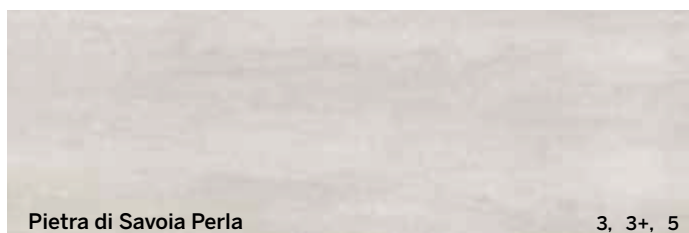
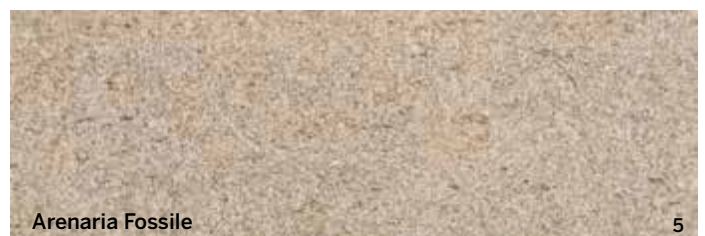
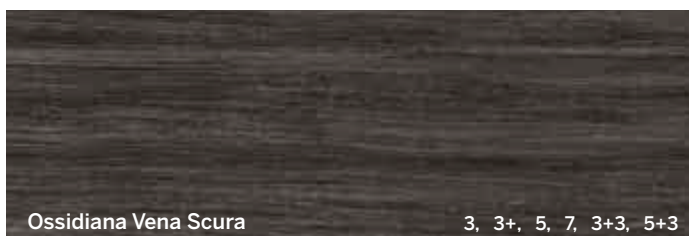

# I NATURALI\_ MARMI

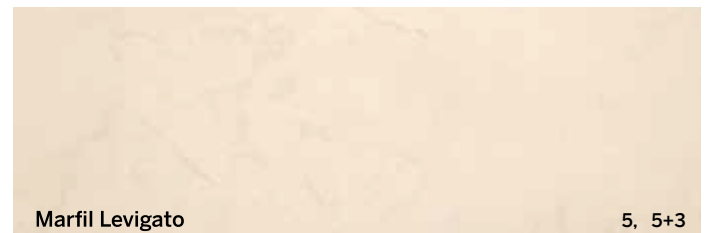

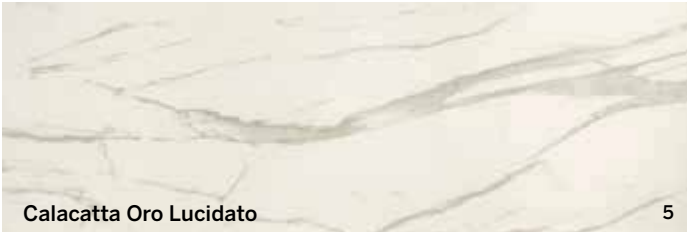

## I NATURALI\_ GEMME



# KAURI



# OXIDE

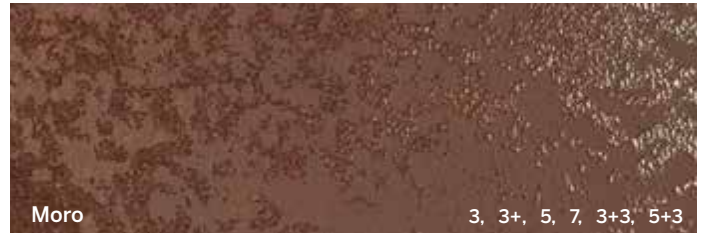
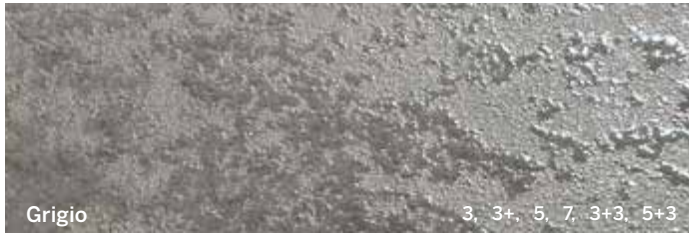



# TREDI

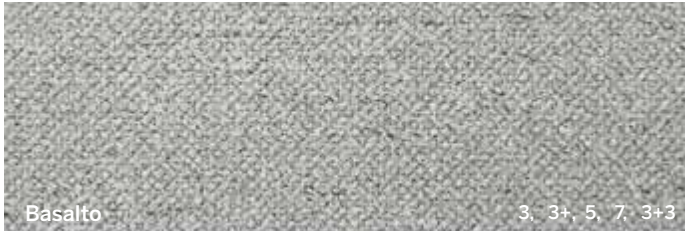

## APPLICATIONS

**SUITABLE FOR MANY INDOOR AND OUTDOOR APPLICATIONS:**

**Construction Industry:**

Floor and wall coverings, partition and storage walls, false ceilings, surface finishes and restoration, insulated panels, tunnels and undergrounds.

**Façade Cladding Systems:**

Ventilated façades, coatings, external claddings.

**Interior Design:**

Surfaces of kitchen and bathroom tops, cupboards, tables, desks, doors and furnishings in general.

**Shipbuilding Sector:**

The lightness and high technical properties make it suitable for floors and walls of cruise and sports crafts.

**Composite and Structural Panels:**

The slabs can be placed on top of each other or over other materials to create extremely light and particularly resistant composite and structural panels suitable in all those cases that require high resistance and reduced weight load on the surface.





## SUM UP • KANKA



## ZOOM • KANKA

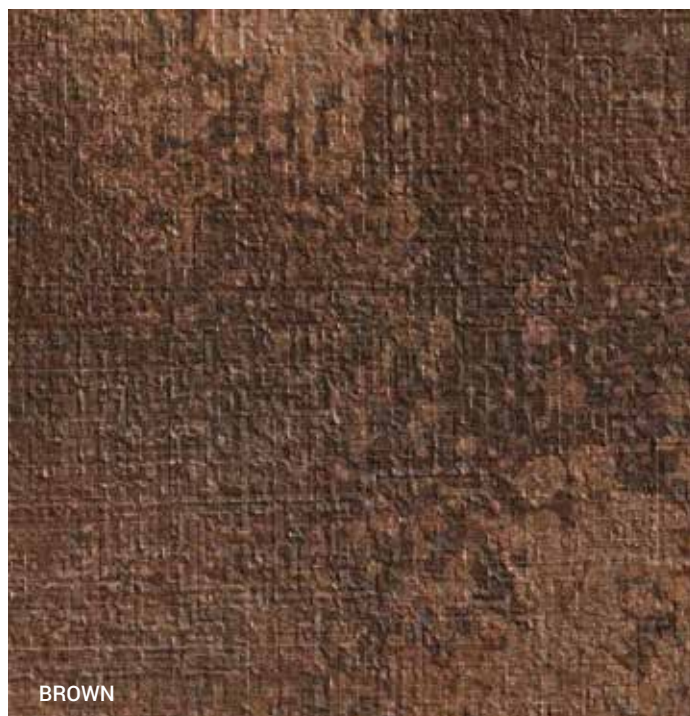
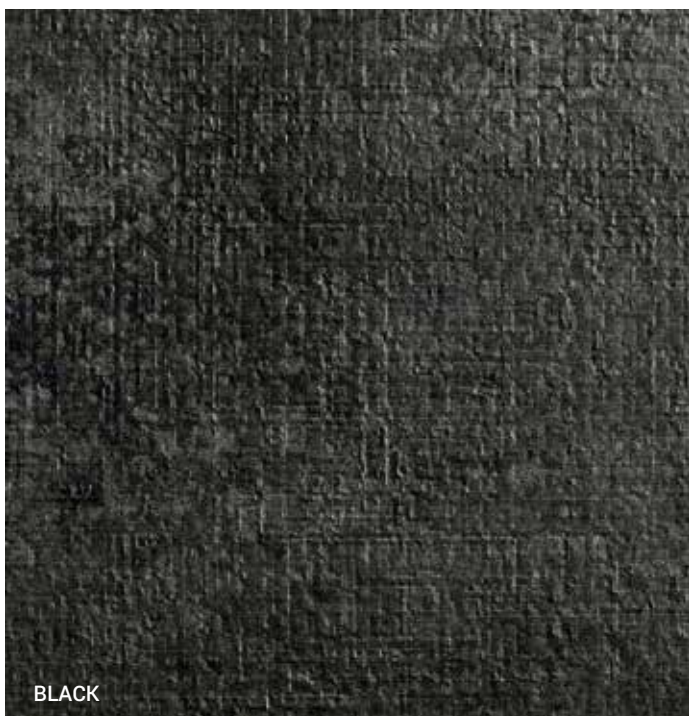

**VARIOUS FACES • KANKA**



## SUM UP • KOTAN



## ZOOM • KOTAN

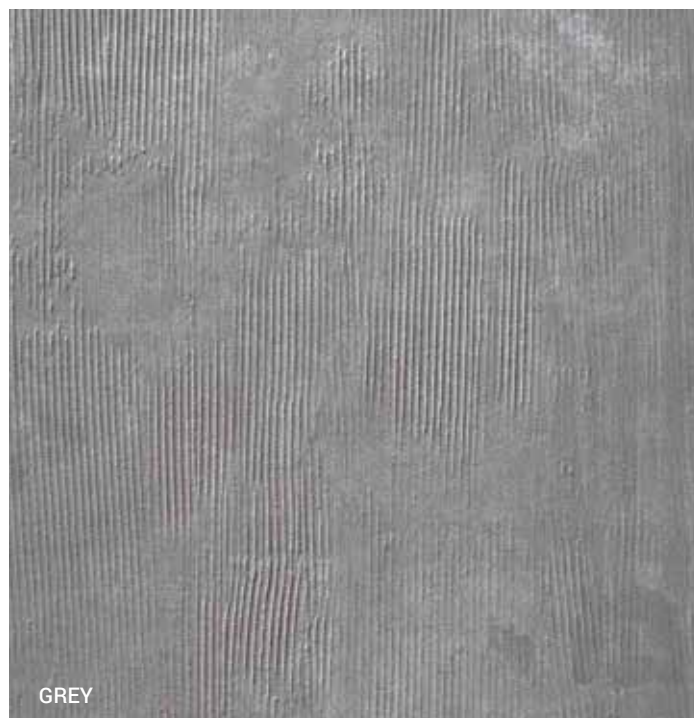

**VARIOUS FACES • KOTAN**



ITALY





ITALY



ITALY





ITALY



150

SOUTH KOREA



SOUTH KOREA



SOUTH KOREA



SOUTH KOREA





ITALY

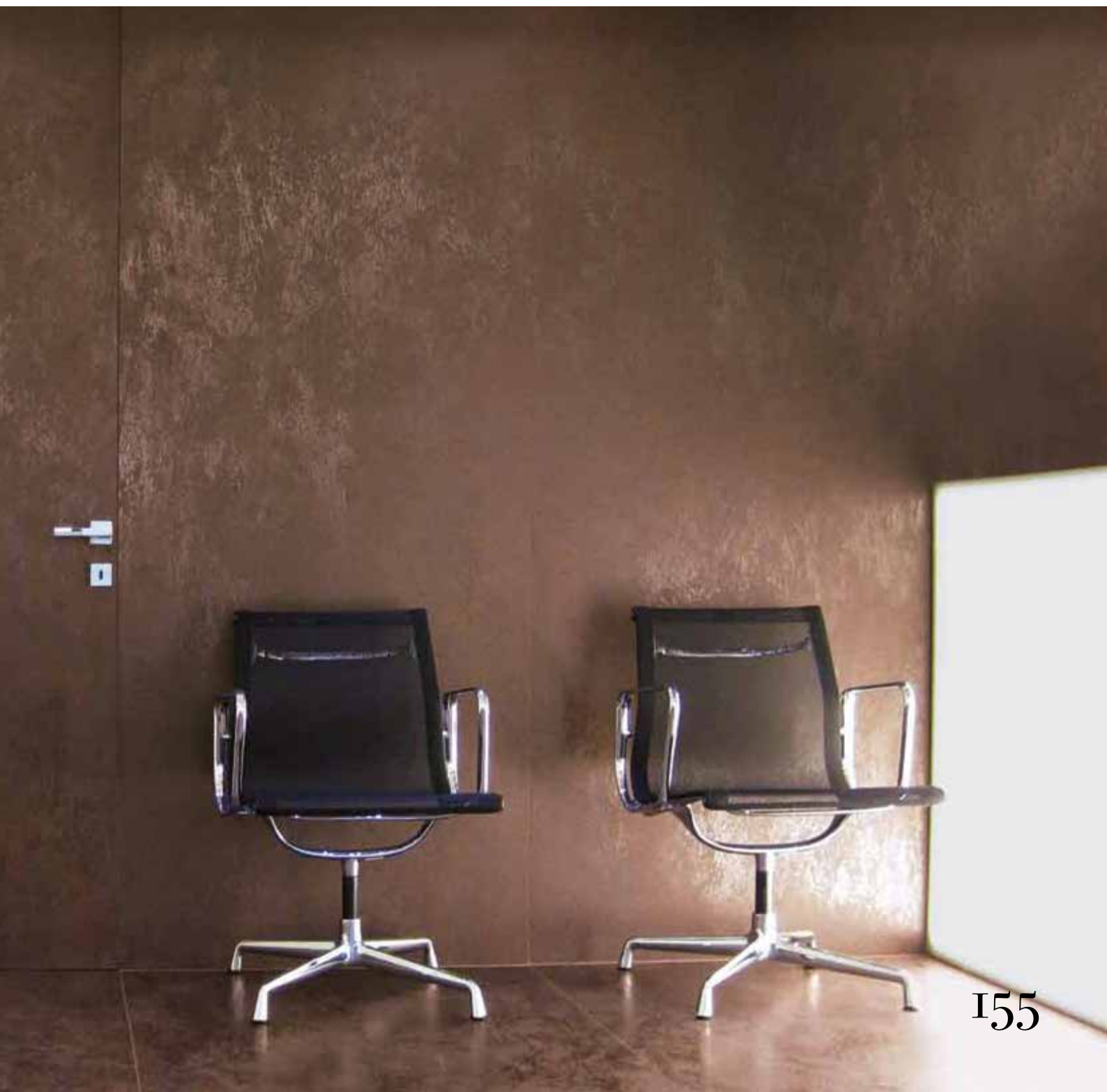

I55

ITALY



156





ITALY







FERRO  
OSSIDATO



PIETRA DI SAVOIA  
GRIGIA



OSSIDIANA  
VENA SCURA



BIANCO STATUARIO  
LUCIDATO



TRAVERTINO  
ROMANO



TRAVERTINO ROMANO  
LUCIDATO

I65

MARFIL  
LUCIDATO

The background of the page is a close-up photograph of a marble surface. It features a light cream or off-white base color with intricate, flowing veins in shades of pale pink, rose gold, and light beige. The veins vary in thickness and direction, creating a complex, organic pattern. The lighting is soft, highlighting the natural texture and subtle color variations of the stone.

BIANCO STATUARIO  
LEVIGATO

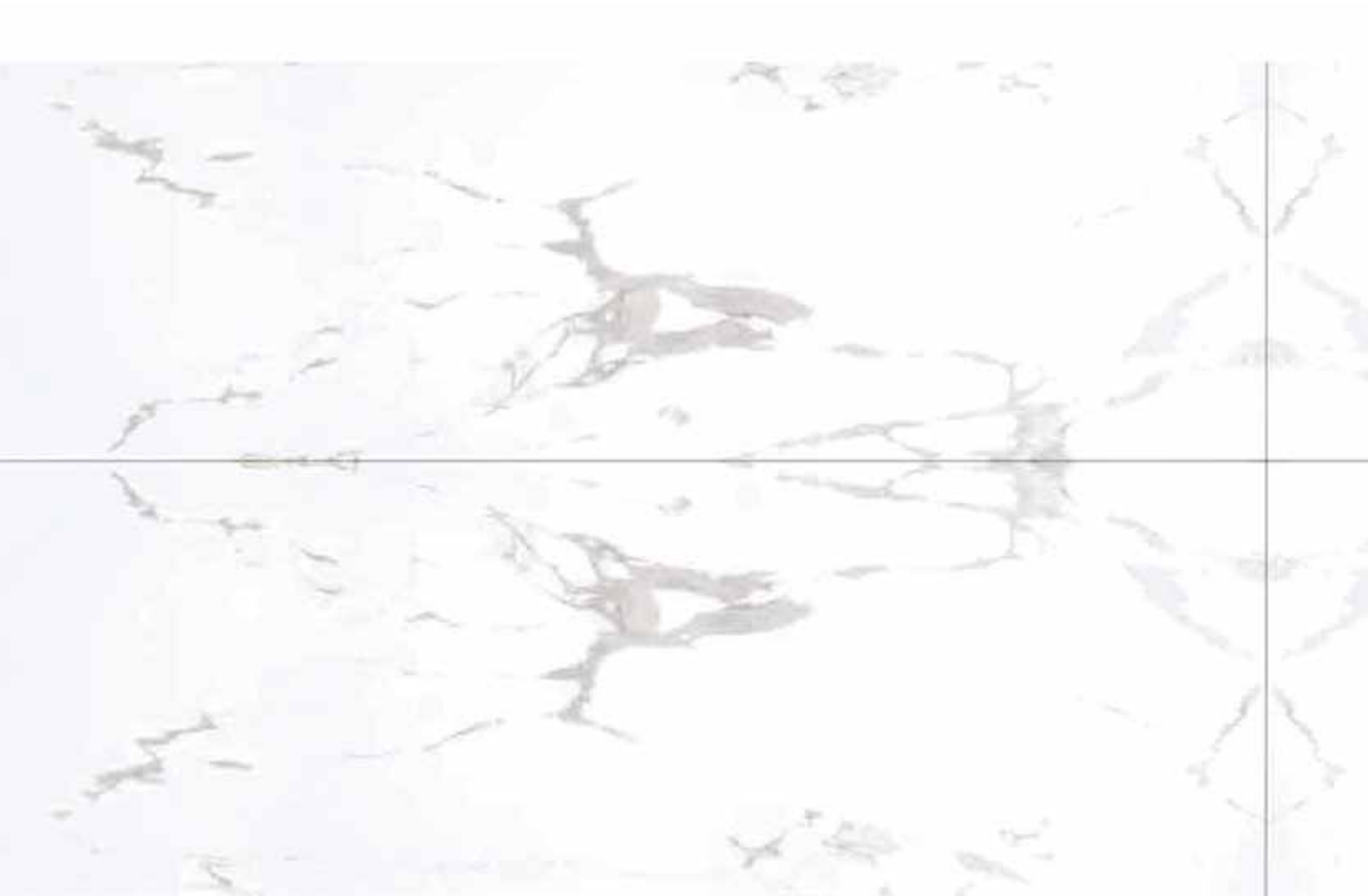



M A D E I N I T A L Y





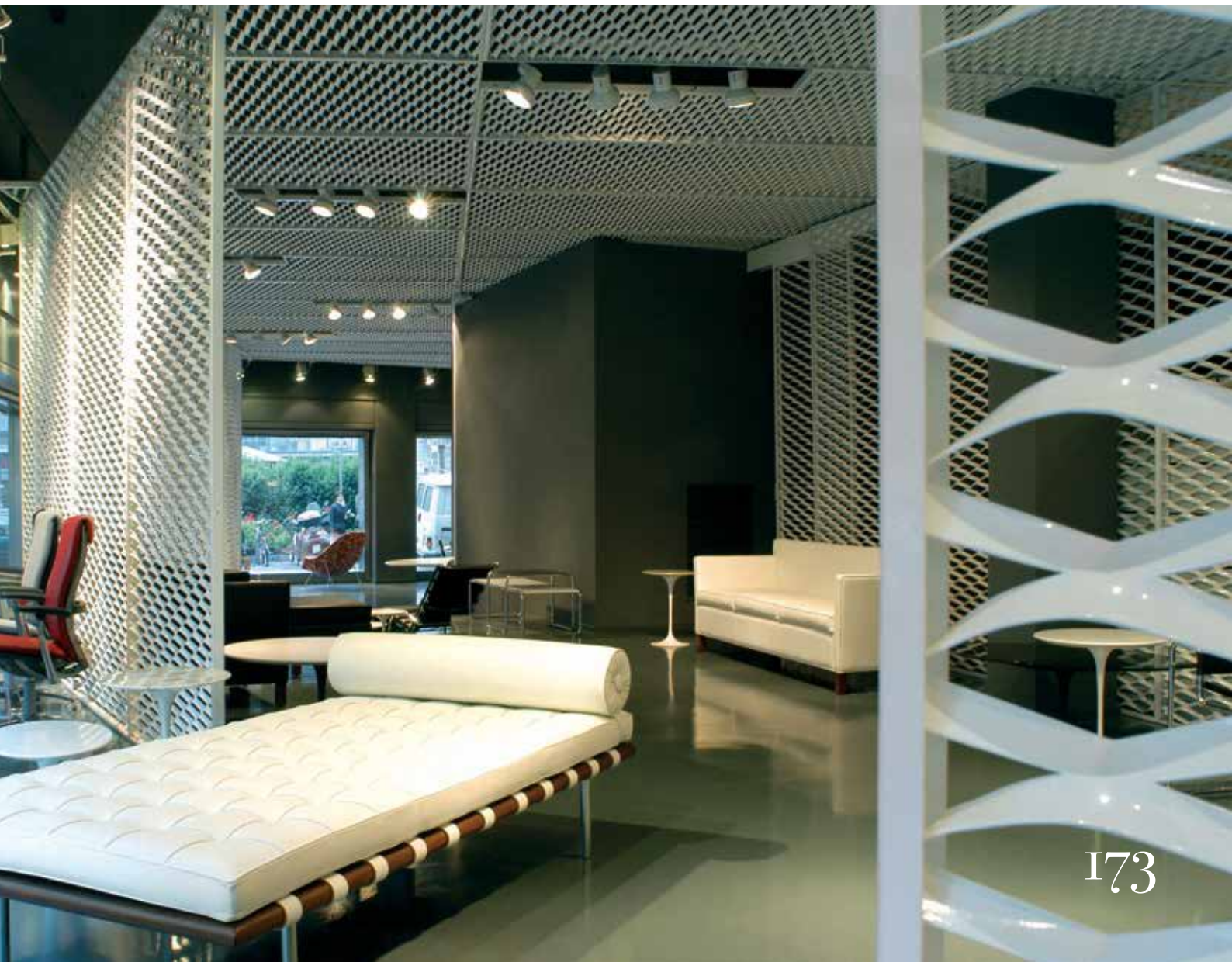

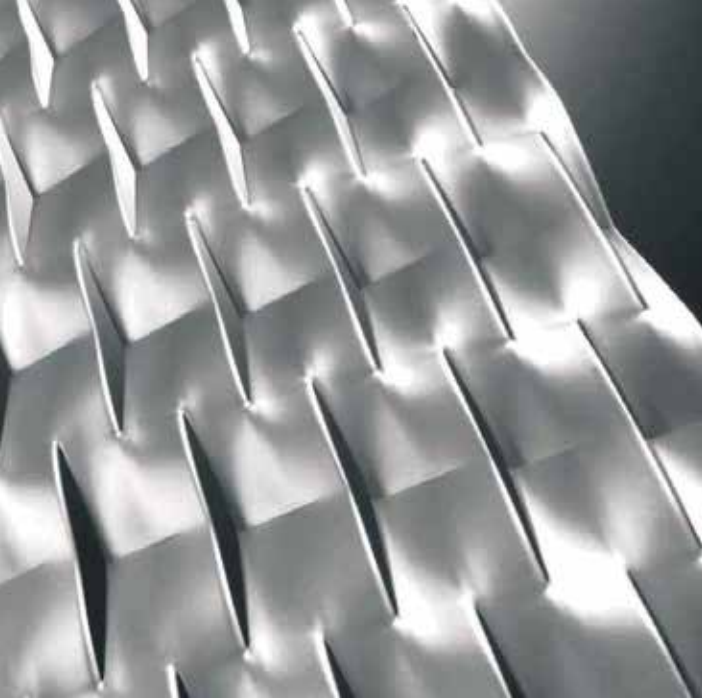

BROKLYN

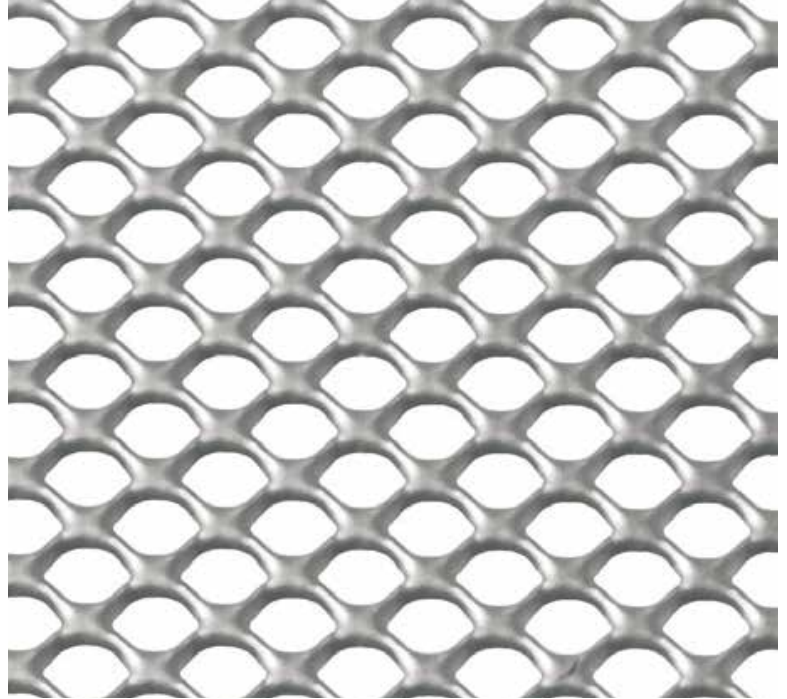

CHELSEA

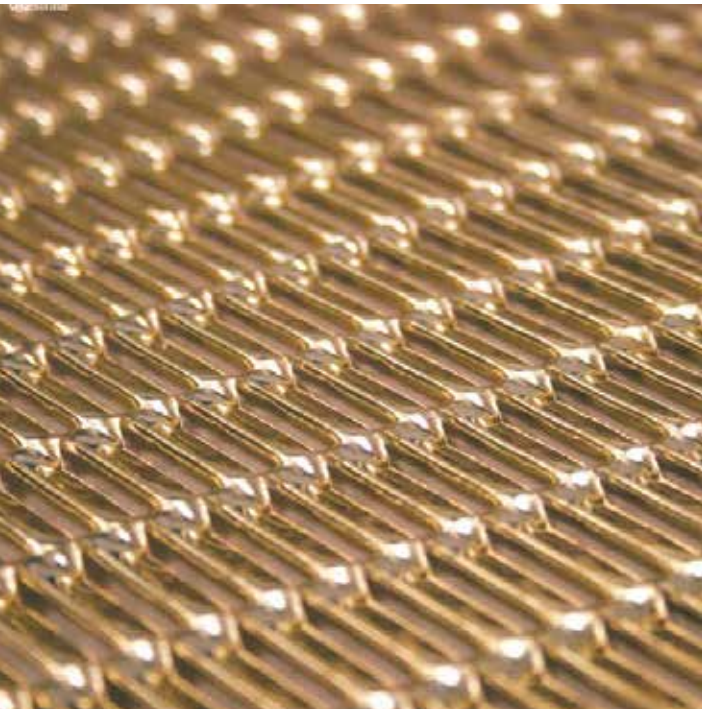

RIBERA



OPERA

OPERA

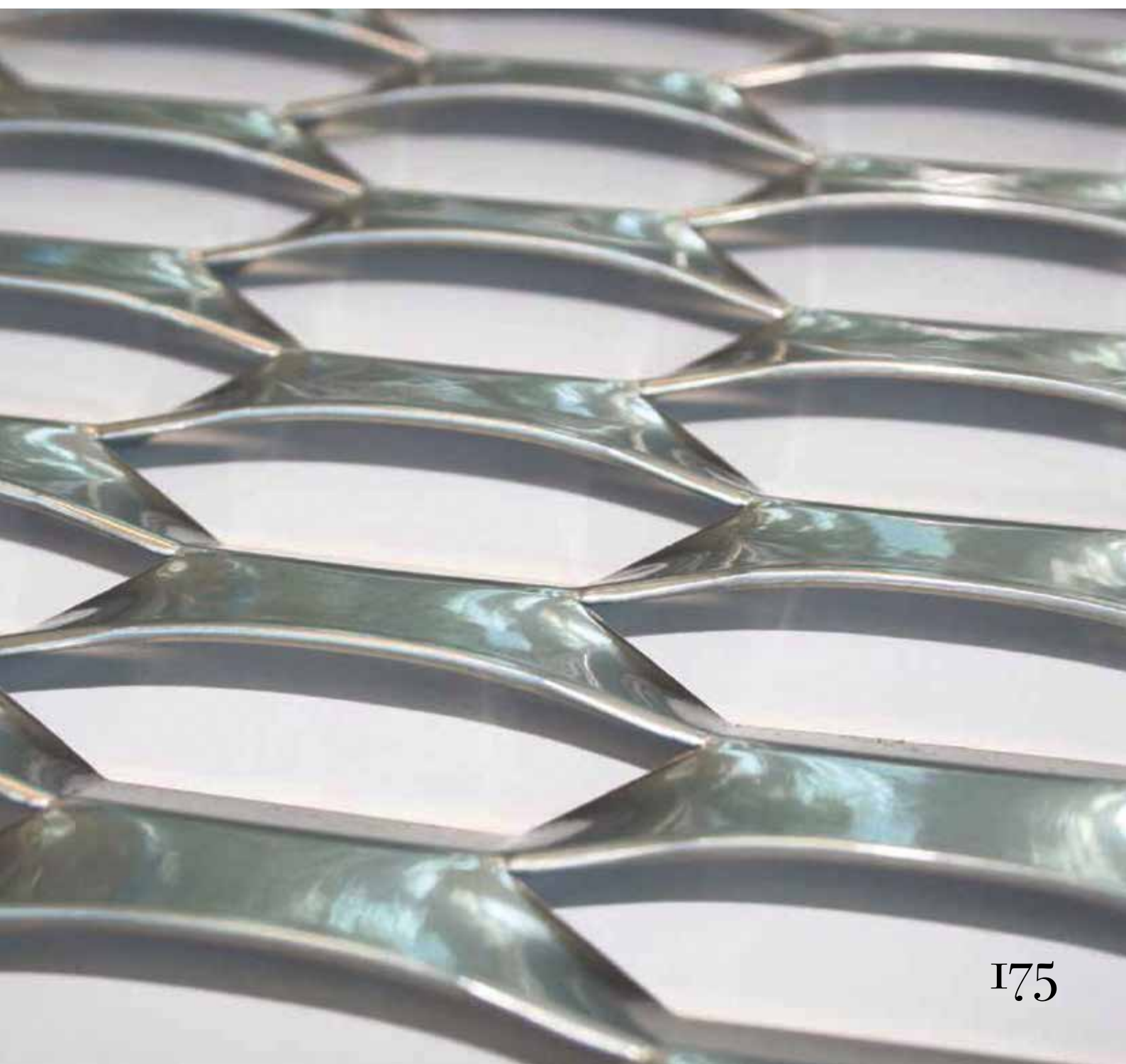

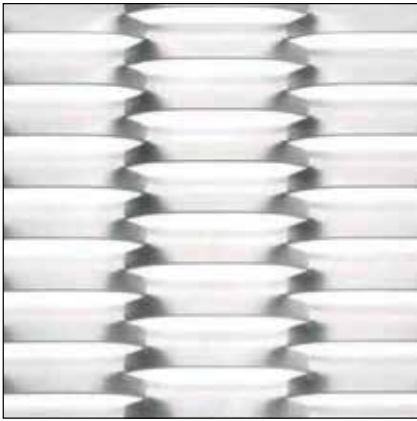

BERG

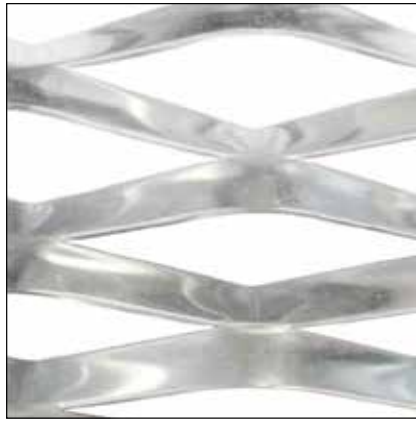

BIG BROADWAY



NOTREDAME

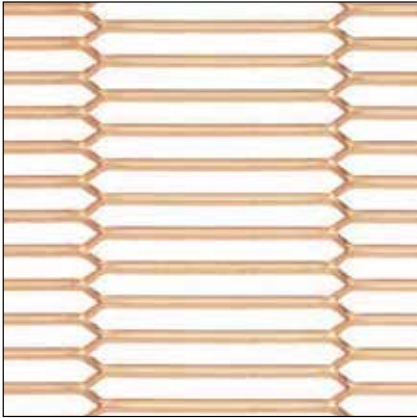

MARAIS

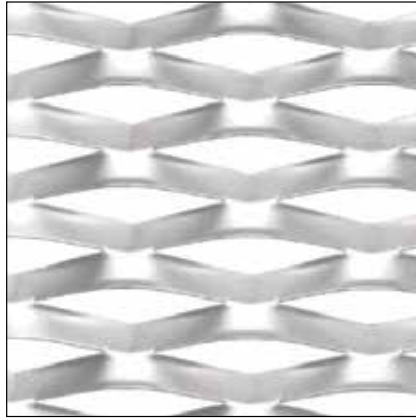

RAVAL



PICADILLY

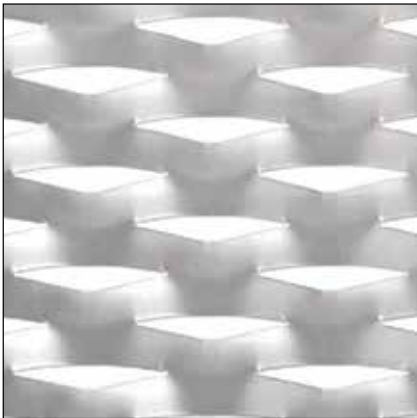

FLAMINIO



EXPO



MARACANA

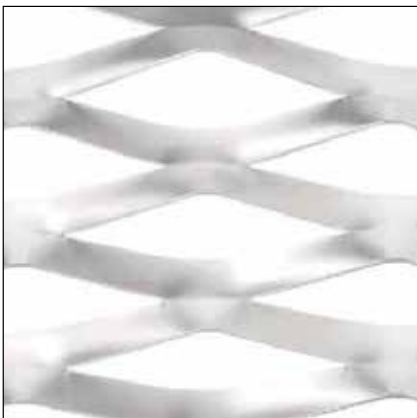

MANHATTAN

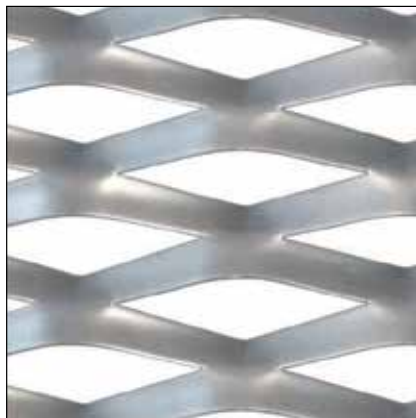

SKYLINE

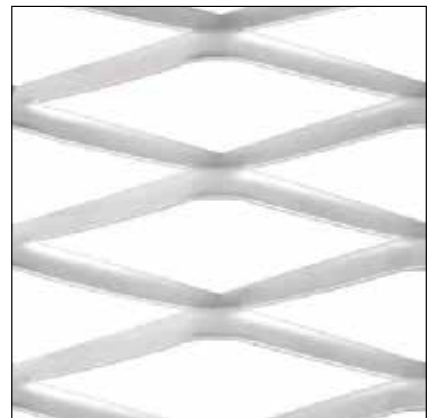

HOLLYWOOD

MANHATTAN

















LUSAIL SPORTS CLUB - QATAR





المحلات التجارية  
Retail Shops

معلومات  
معلومات  
معلومات



DUBAI CREEK - FACADE CLADDING VIEW - UAE







MATRIX TOWER - DUBAI SPORTS CITY - UAE



SWITZERLAND



MILANO • ITALY





CANOPY/SUNSCREEN PROJECT - PRIVATE - UK



EXHIBITION BUILDING - ITALY



OFFICE BUILDING - ITALY



ATHENS CONCERT HALL - GREECE

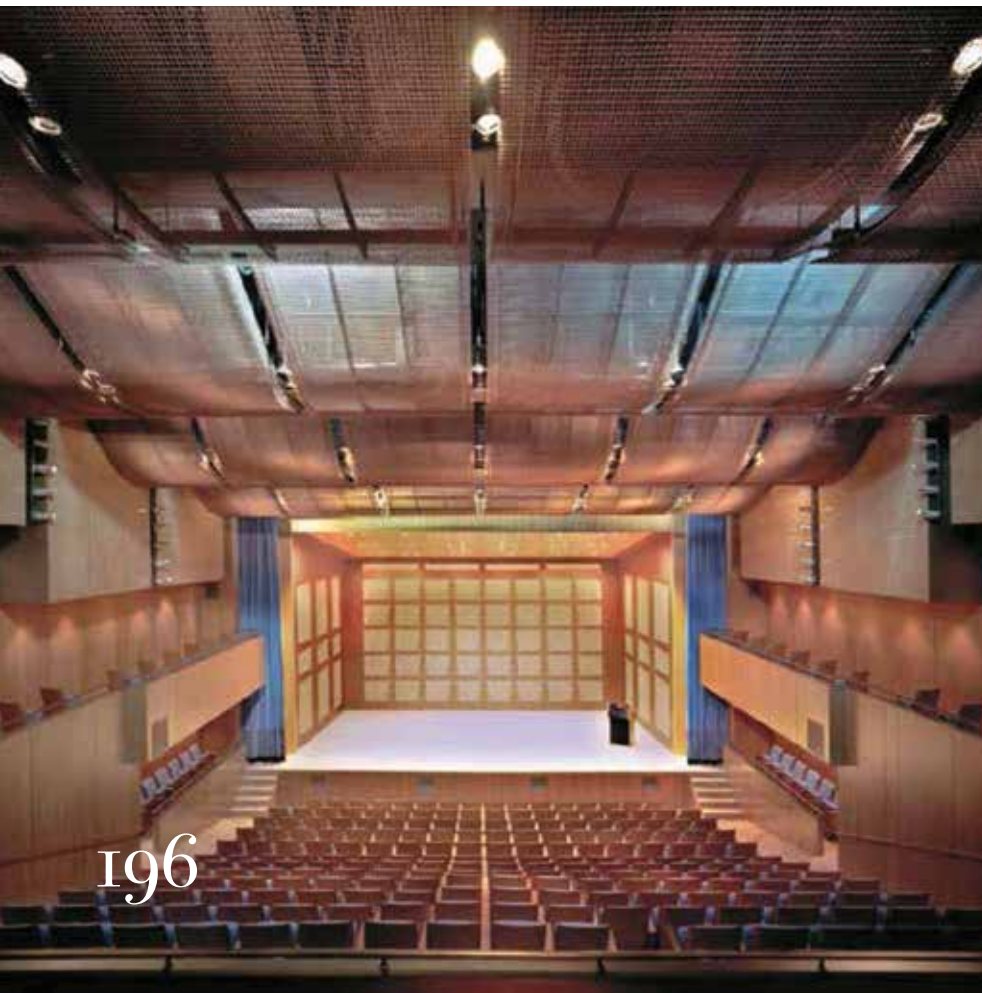

196





ATHENS - GREECE



EXHIBITION BUILDING - ITALY

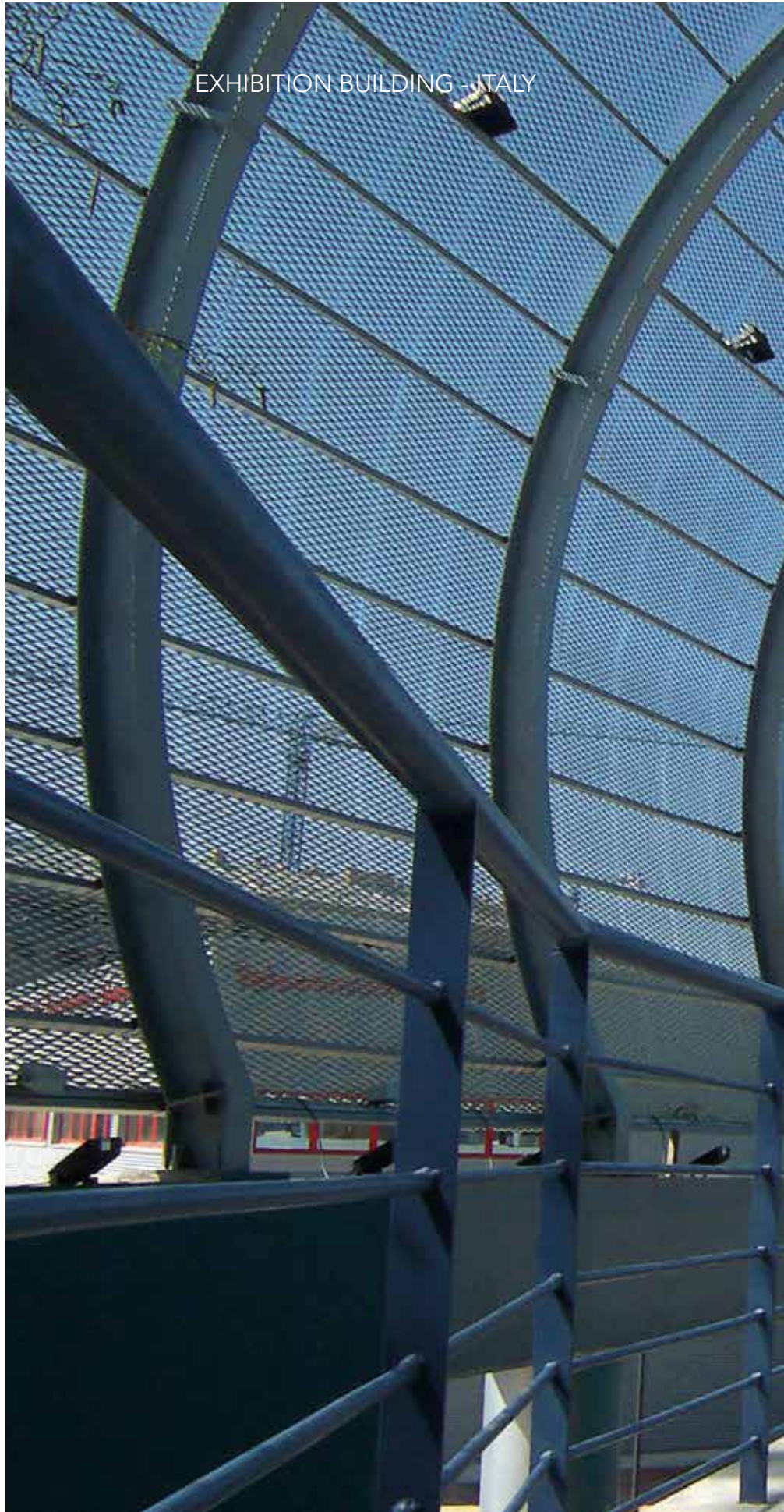

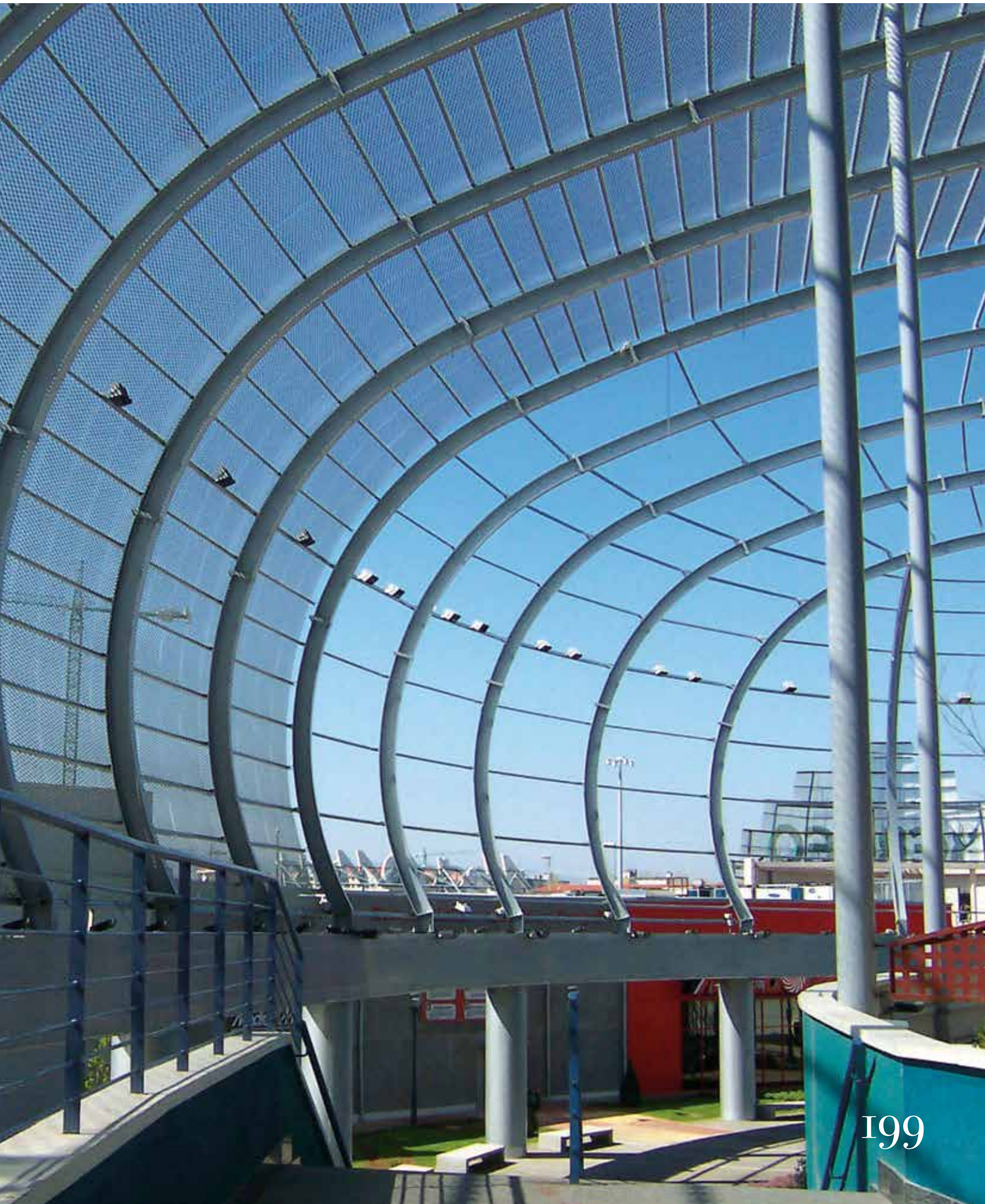

STADIUM PROJECT - BRAZIL







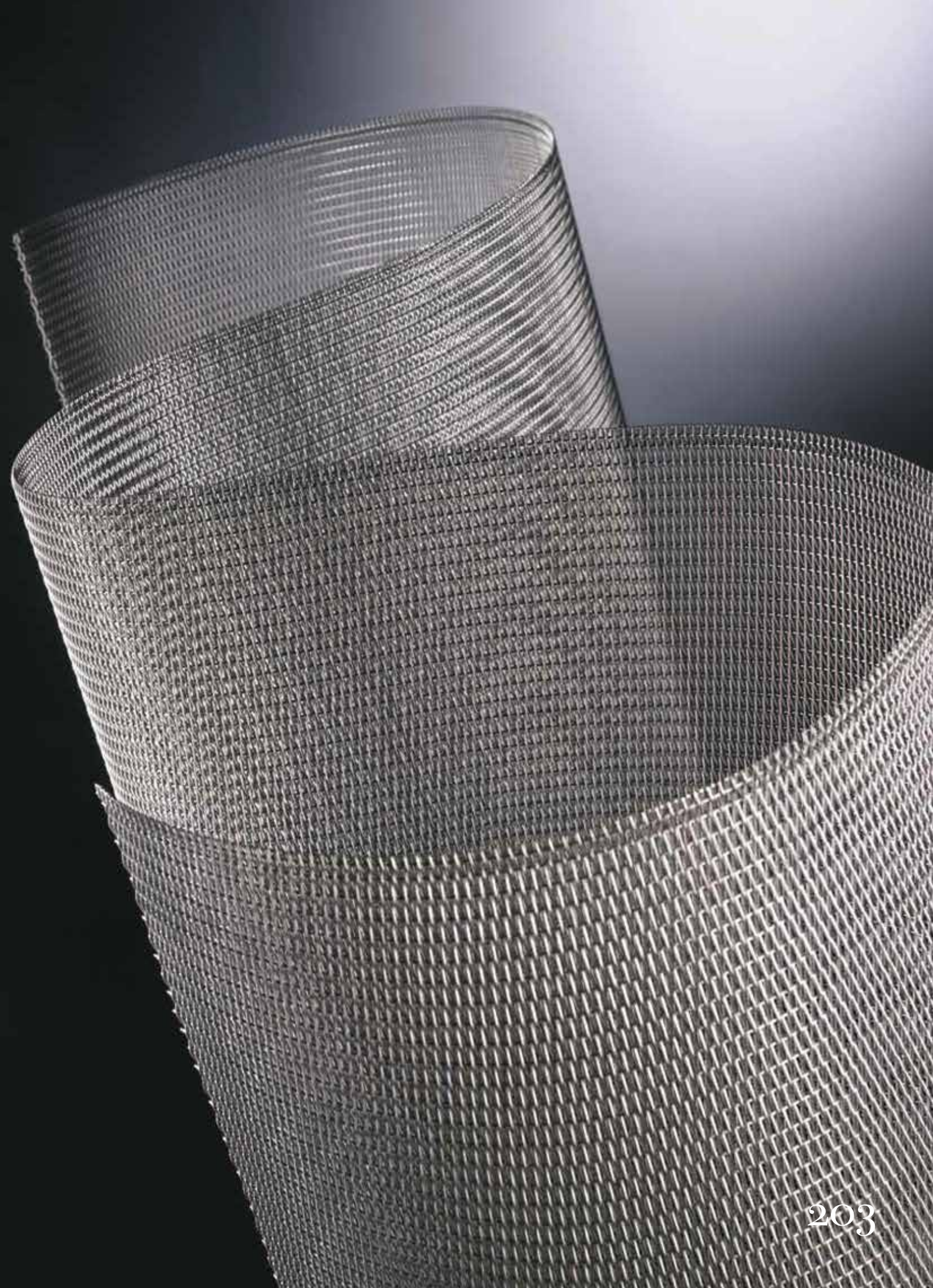

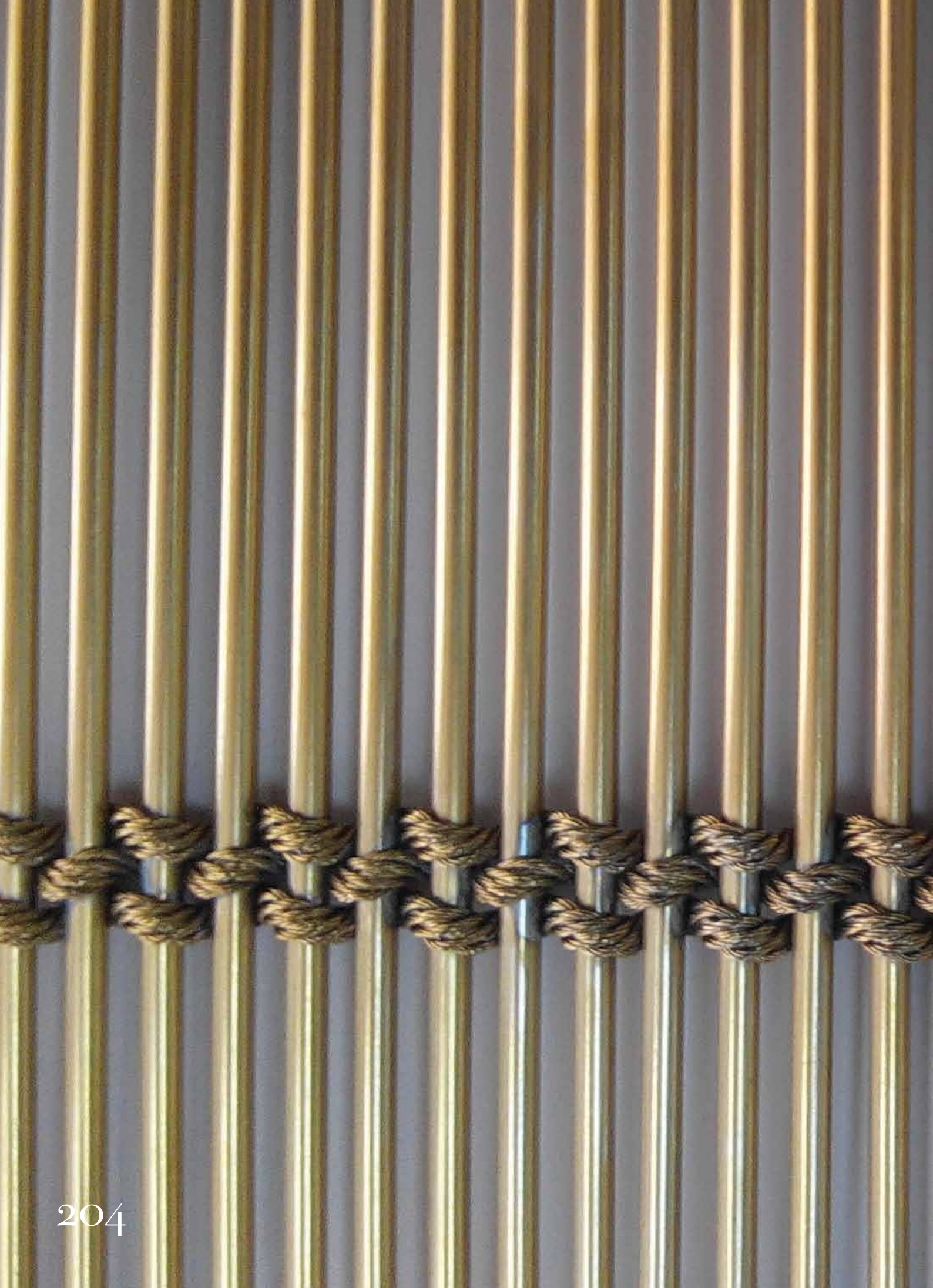



TWEED

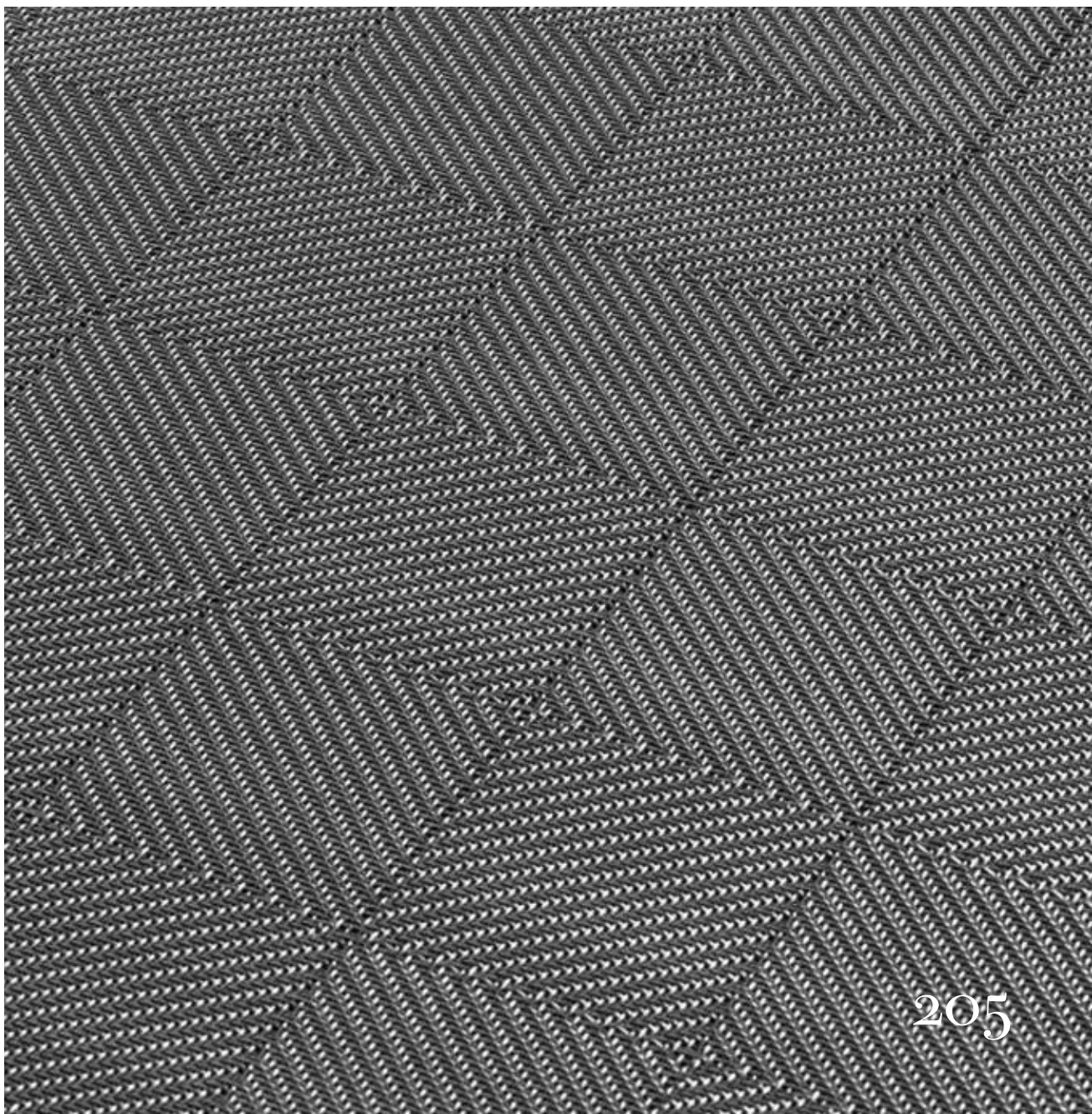

M A D E I N I T A L Y



## FIXING SYSTEMS



Direct U



DirectFix 4U



DirectFix UW



DirectFix T



DirectFix TL



HangFix L-back



HangFix L-front



HangFix L-bent



HangFix T-side



# Direct U

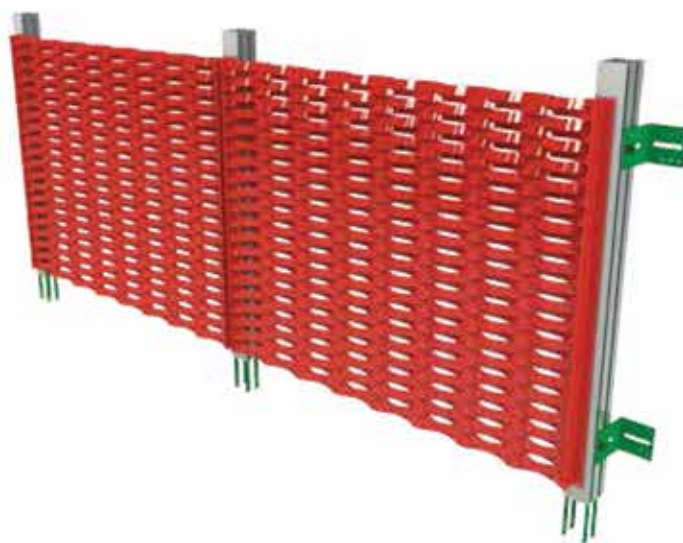

# DirectFix 4U

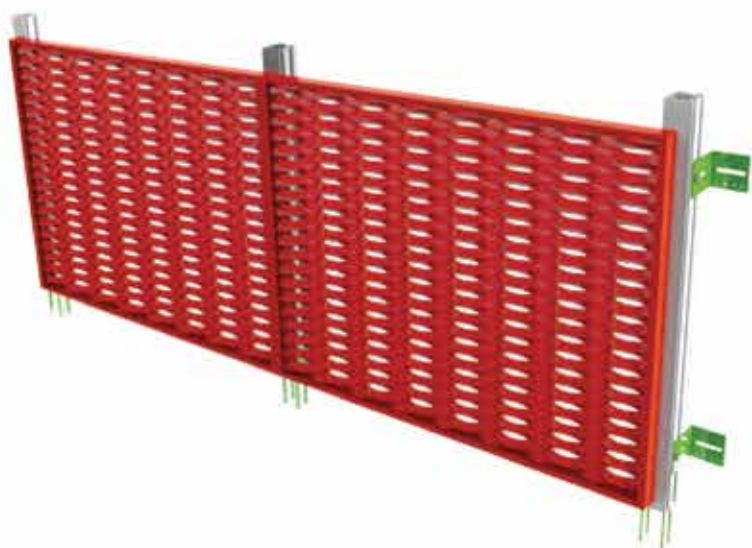

# DirectFix UW

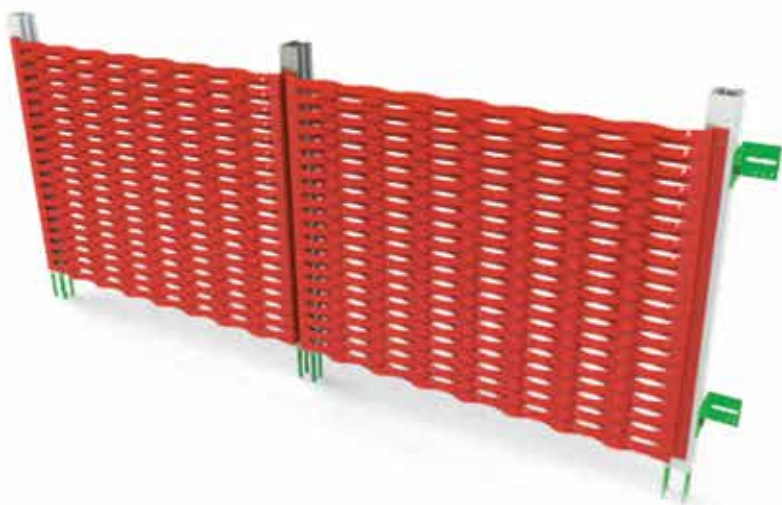

## DirectFix T

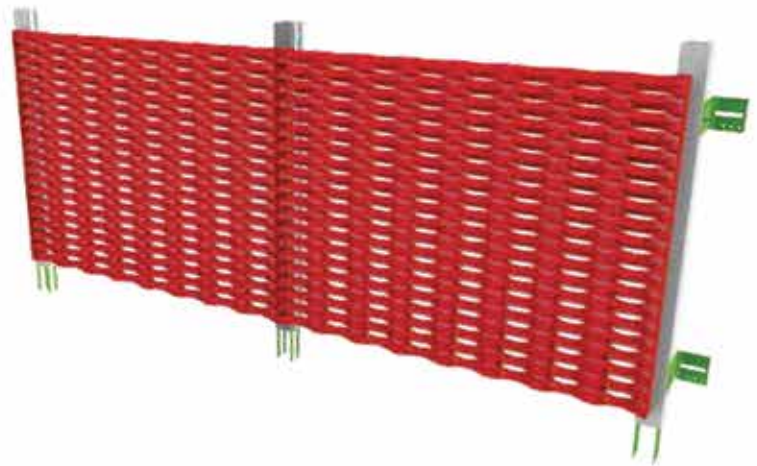

## DirectFix TL

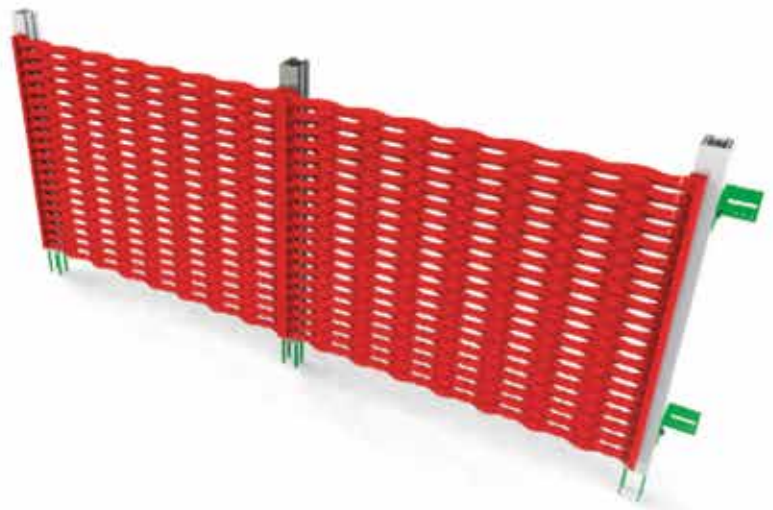

## HangFix L-back

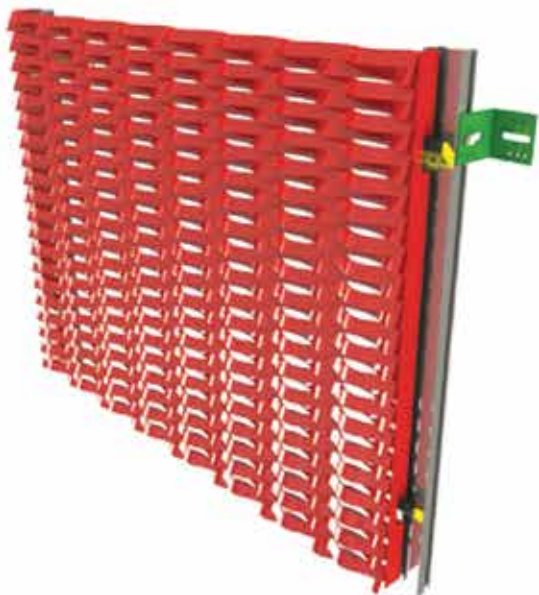

## HangFix L-front

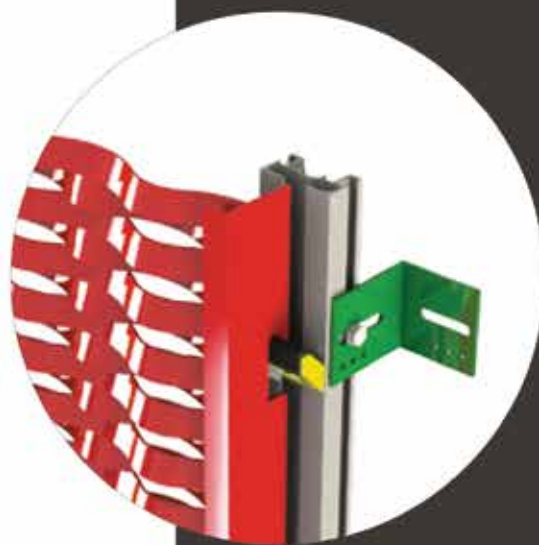

## HangFix L-bent

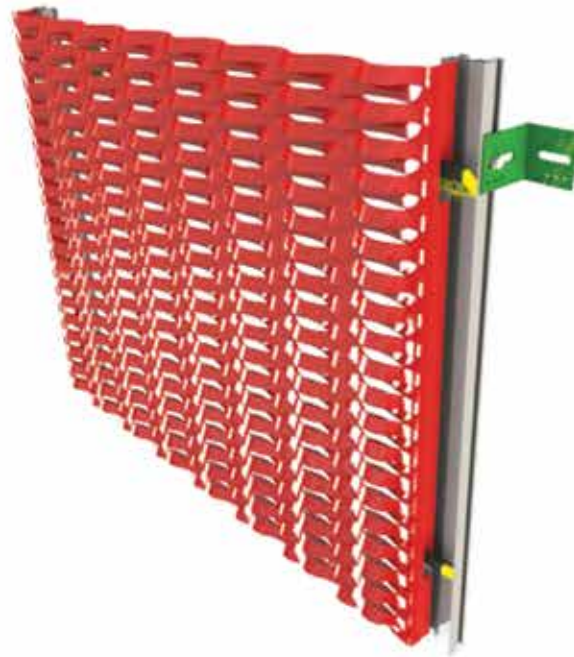
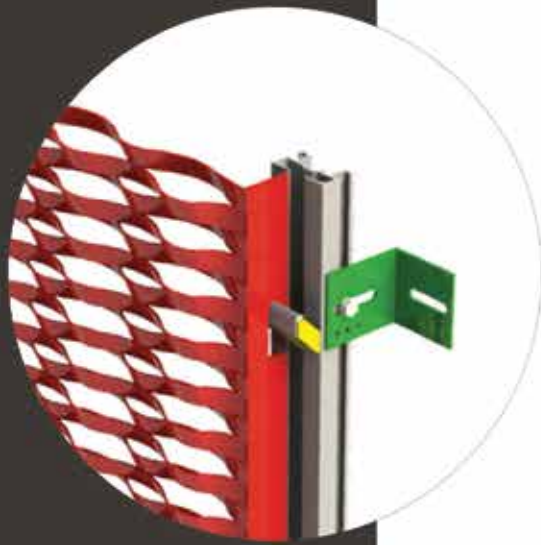

## HangFix T-side

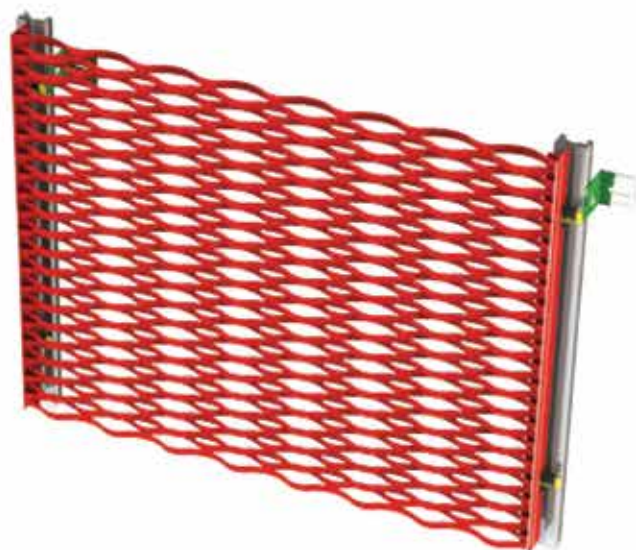
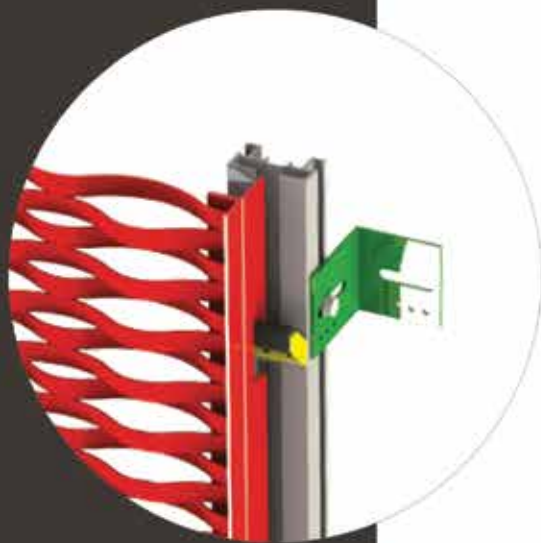



# BAC

Bended and framed panels

## SIZE OPTIONS

A - from 250 up to 600 mm

L - up to 3000 mm

H - 30 / 40 / 50 mm

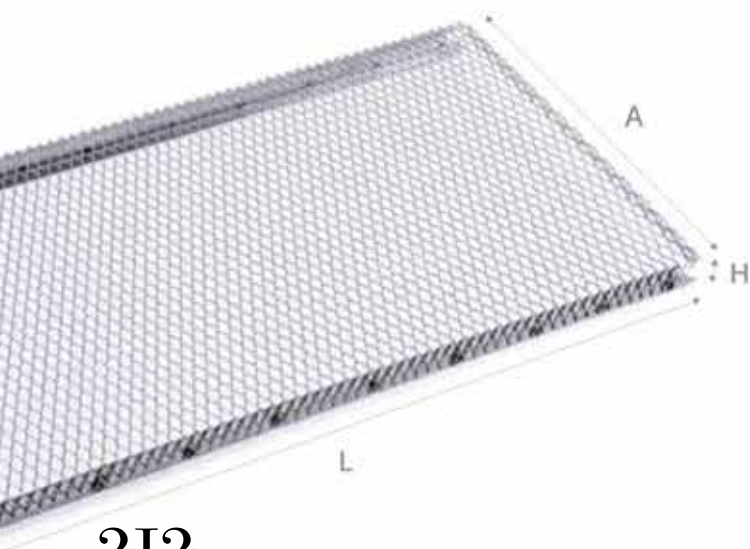

## MESH OPTIONS

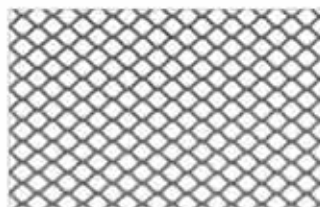

Q6 × 4.5 × 1.2 × 1

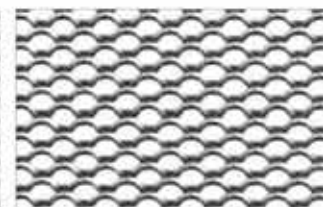

D10 × 7 × 1.5 × 1 flattened

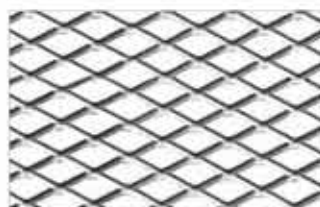

16 × 8 × 2 × 1

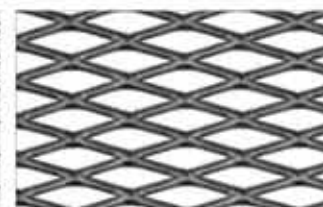

29 × 10 × 2 × 1.5



40 × 17 × 2.2 × 1.5



62 × 23 × 8 × 0.6



Basic

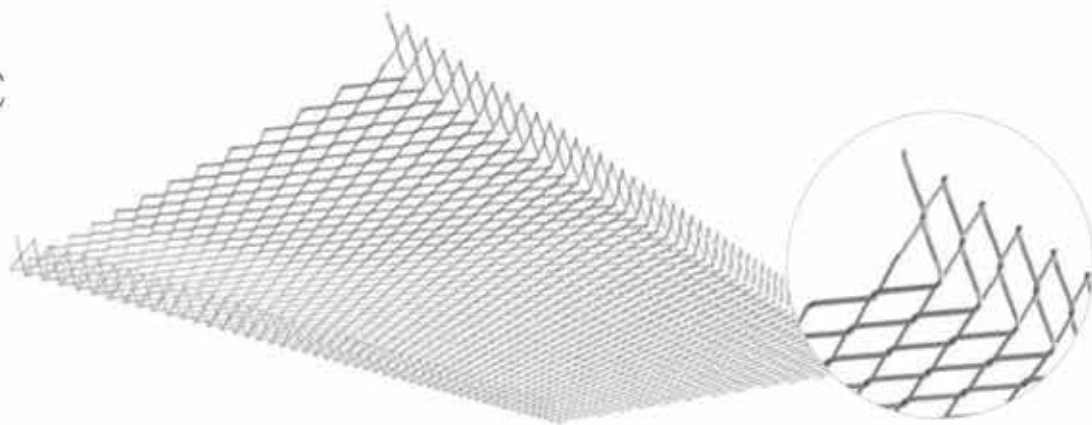

Module

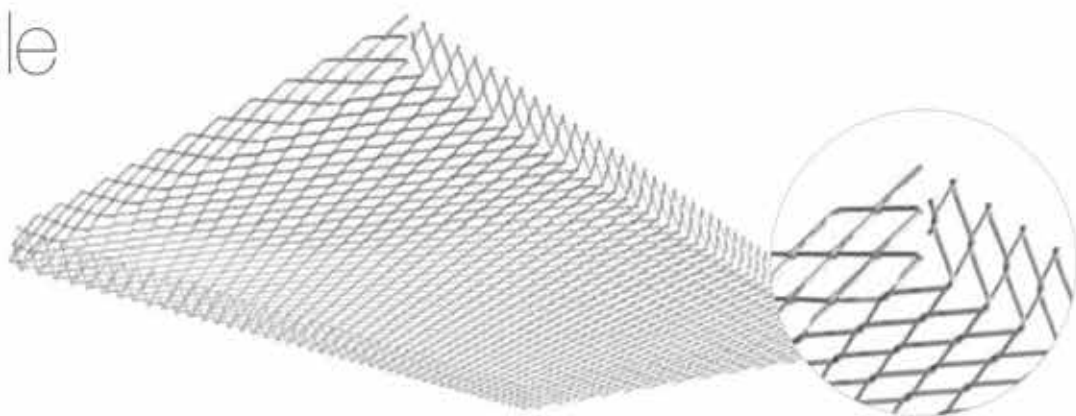

Evo



Evo Plus



# MESH TYPES

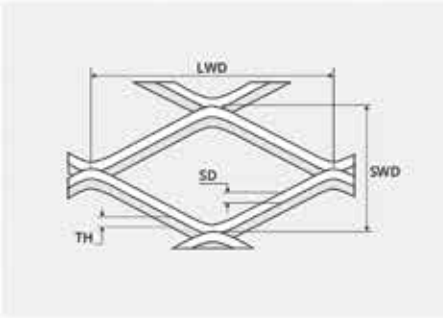

## LEGEND

- LWD: Long way diagonal
- SWD: Short way diagonal
- SW: Strand width
- TH: Thickness
- Open Area
- Material
- Weight

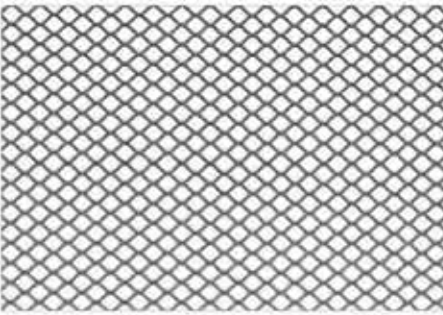

### Q6 x 4.5 x 1.2 x 1

LWD	SWD	SW	TH	Open Area	Material	Weight
6 mm	4.5 mm	1.2 mm	1 mm	60 %	Aluminium	1.45 Kg/mq
Mild steel, galvanized steel, stainless steel						4.20 Kg/mq

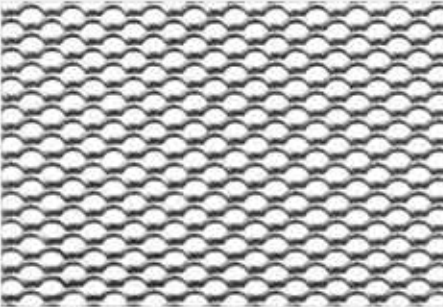

### D10 x 7 x 1.5 x 1 flattened

LWD	SWD	SW	TH	Open Area	Material	Weight
10 mm	7 mm	1.5 mm	1 mm	58 %	Aluminium	1.15 Kg/mq
Mild steel, galvanized steel, stainless steel						3.30 Kg/mq

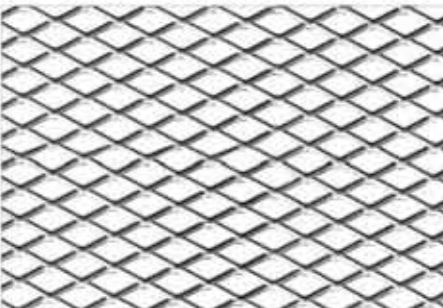

### 16 x 8 x 2 x 1

LWD	SWD	SW	TH	Open Area	Material	Weight
16 mm	8 mm	2 mm	1 mm	63 %	Aluminium	1.00 Kg/mq
Mild steel, galvanized steel, stainless steel						3.00 Kg/mq

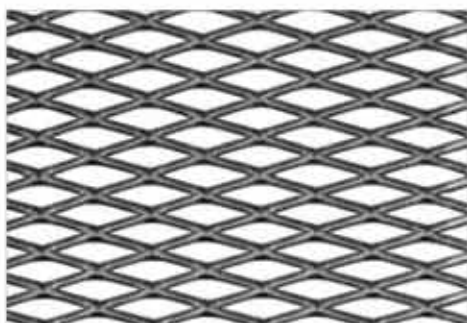

### 29 x 10 x 2 x 1.5

LWD	SWD	SW	TH	Open Area	Material	Weight
29 mm	10 mm	2 mm	1.5 mm	60 %	Aluminium	1.65 Kg/mq
Mild steel, galvanized steel, stainless steel						4.75 Kg/mq



### 40 x 17 x 2.2 x 1.5

LWD	SWD	SW	TH	Open Area	Material	Weight
40 mm	17 mm	2.2 mm	1.5 mm	70 %	Aluminium	1.05 Kg/mq
Mild steel, galvanized steel, stainless steel						3.05 Kg/mq

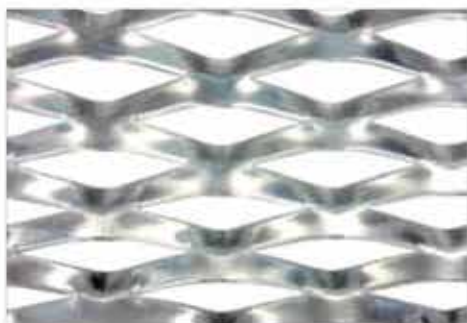

### 62 x 23 x 8 x 0.6

LWD	SWD	SW	TH	Open Area	Material	Weight
62 mm	23 mm	8 mm	0.6 mm	35 %	Aluminium	1.15 Kg/mq
Mild steel, galvanized steel, stainless steel						3.30 Kg/mq

M A D E I N I T A L Y



DUBAI



URBAN LANDSCAPE





URBAN LANDSCAPE













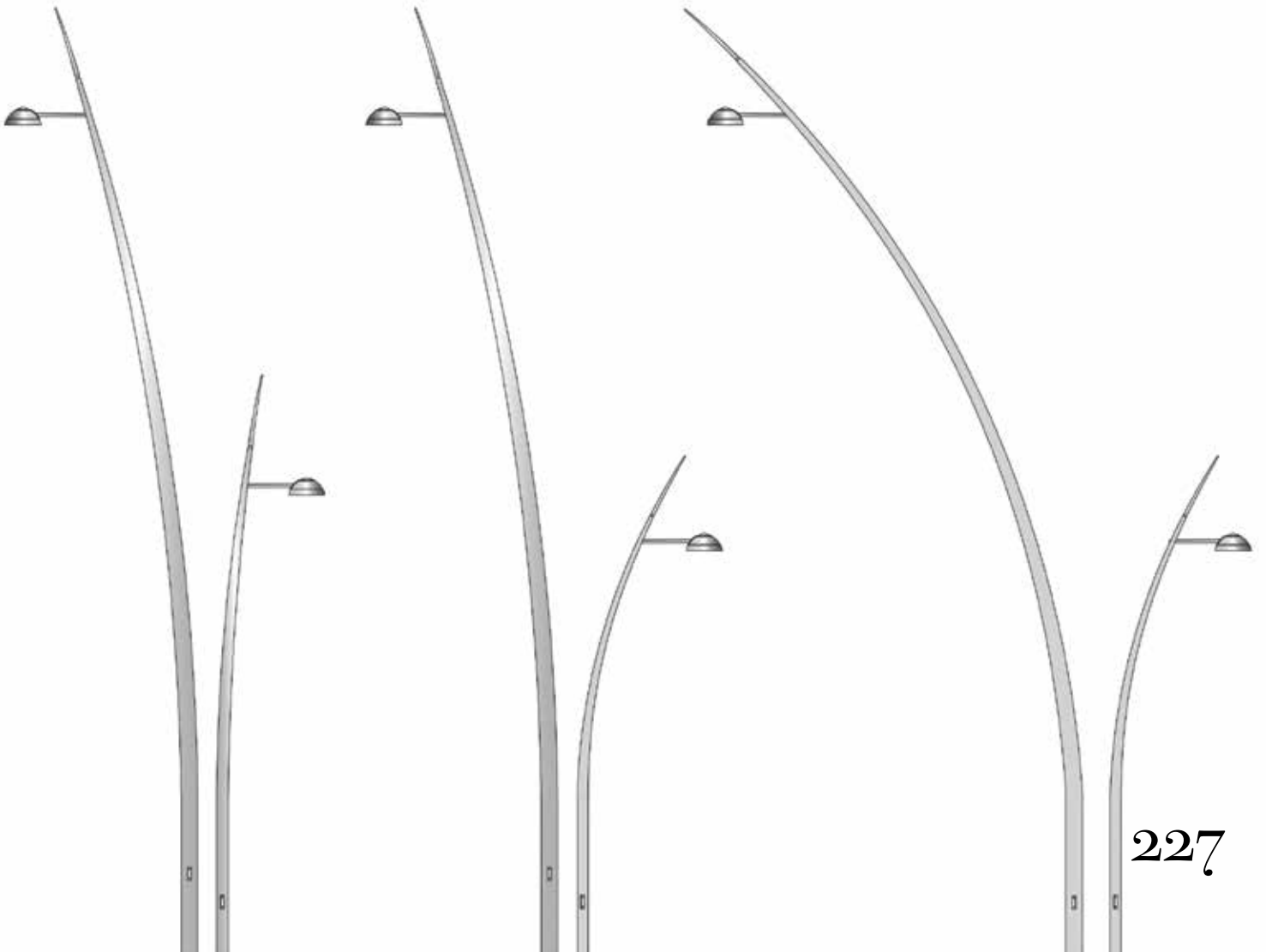



OVER ONE



SLIM ONE



UP ONE

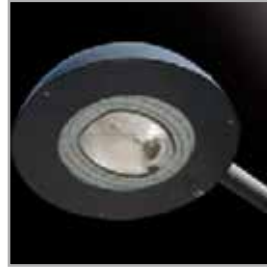

HOLL ONE



VIPER LIGHTING FIXTURE



SMATH LIGHTING FIXTURE



FLAMINGO



SELENE



NBT/91



NBT/92



HOLL ONE







UP ONE







VIPER

















HBT/92



241

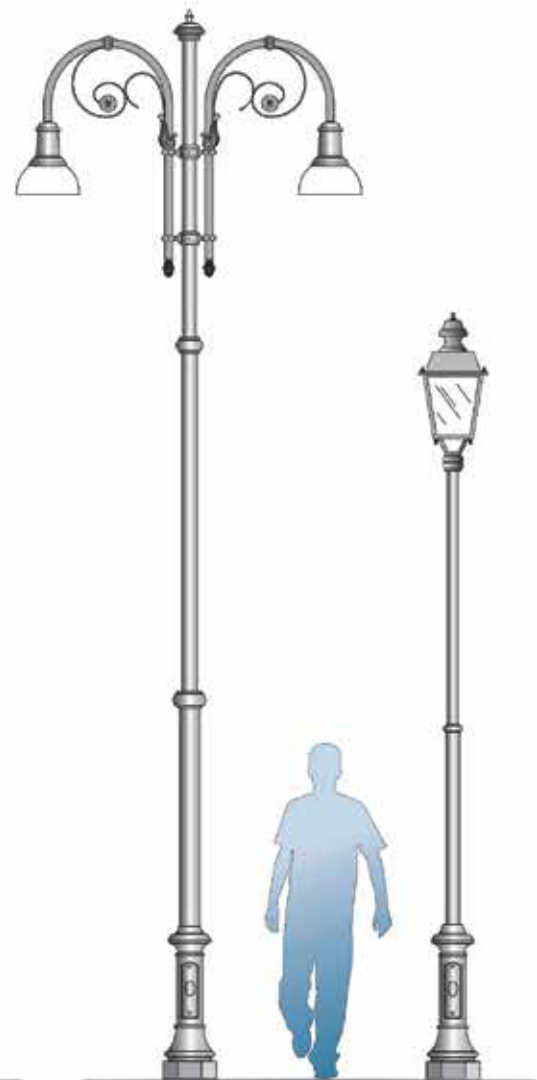
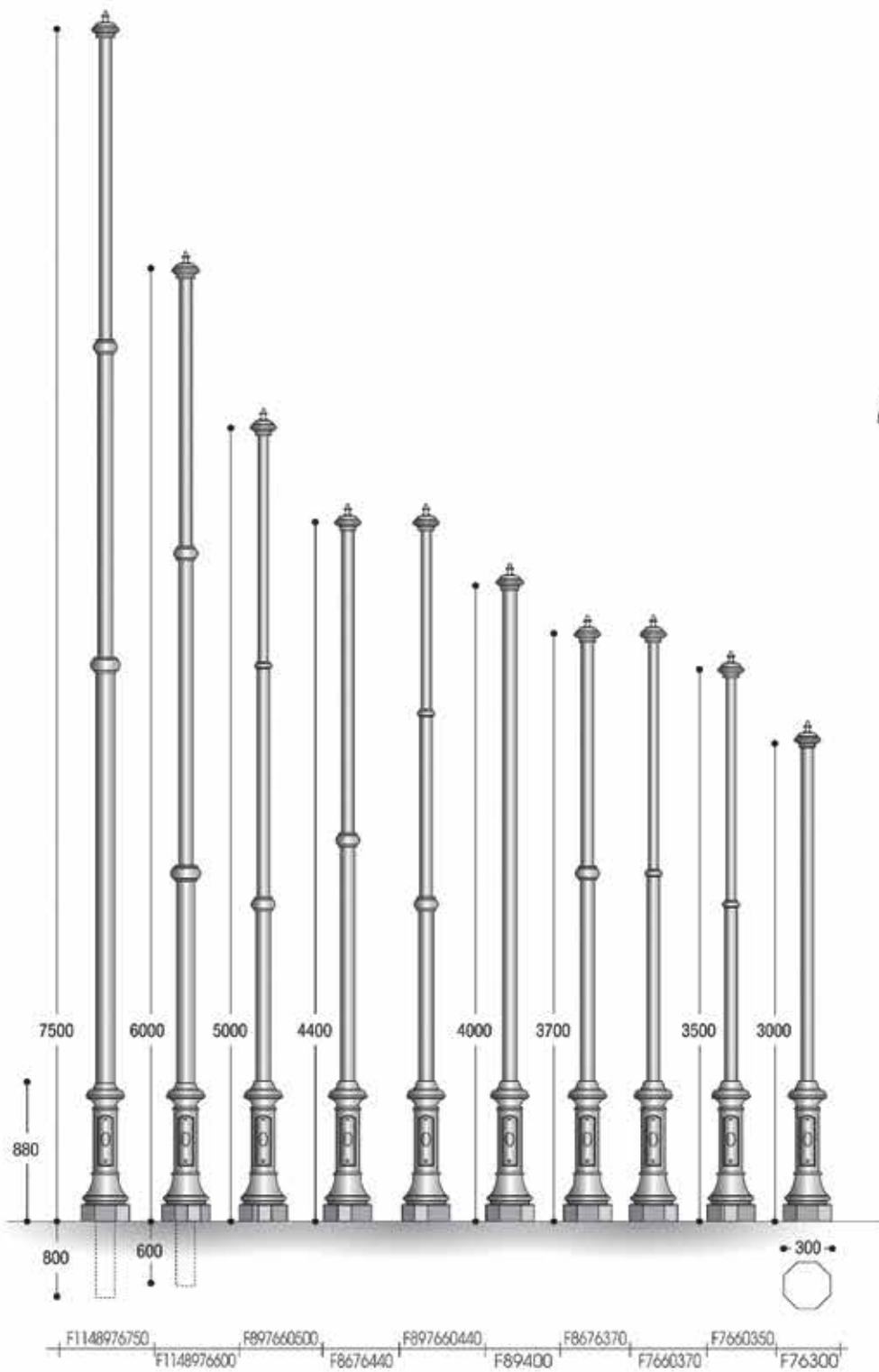

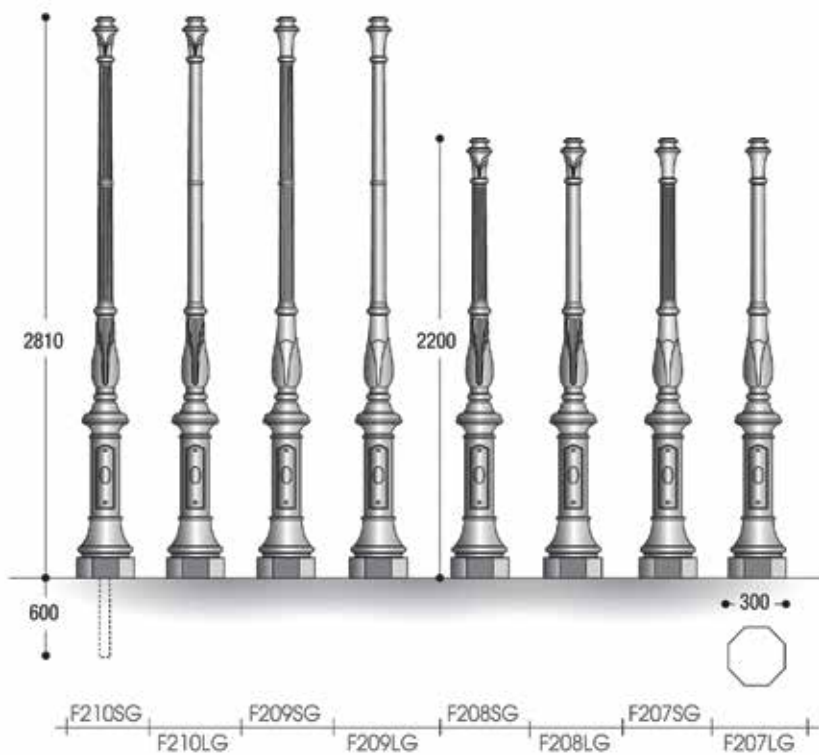

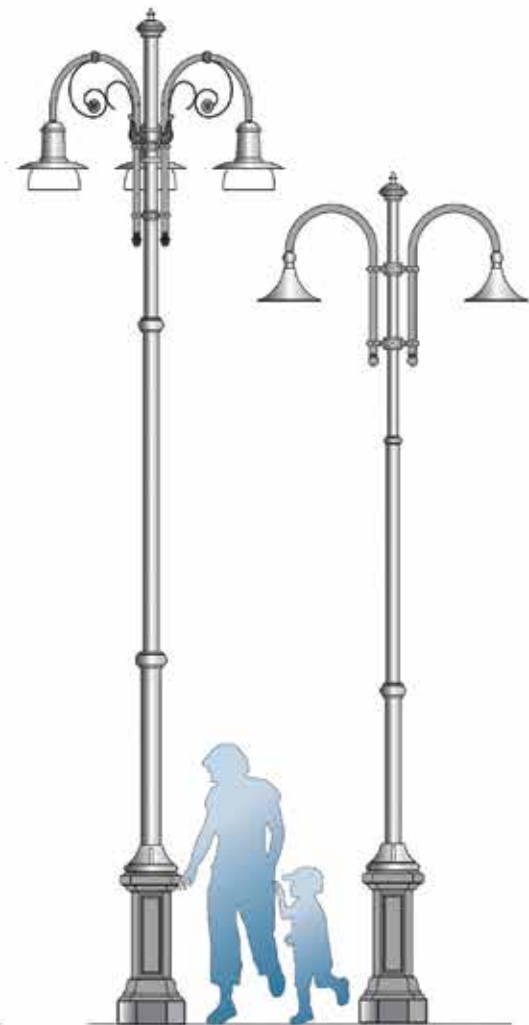
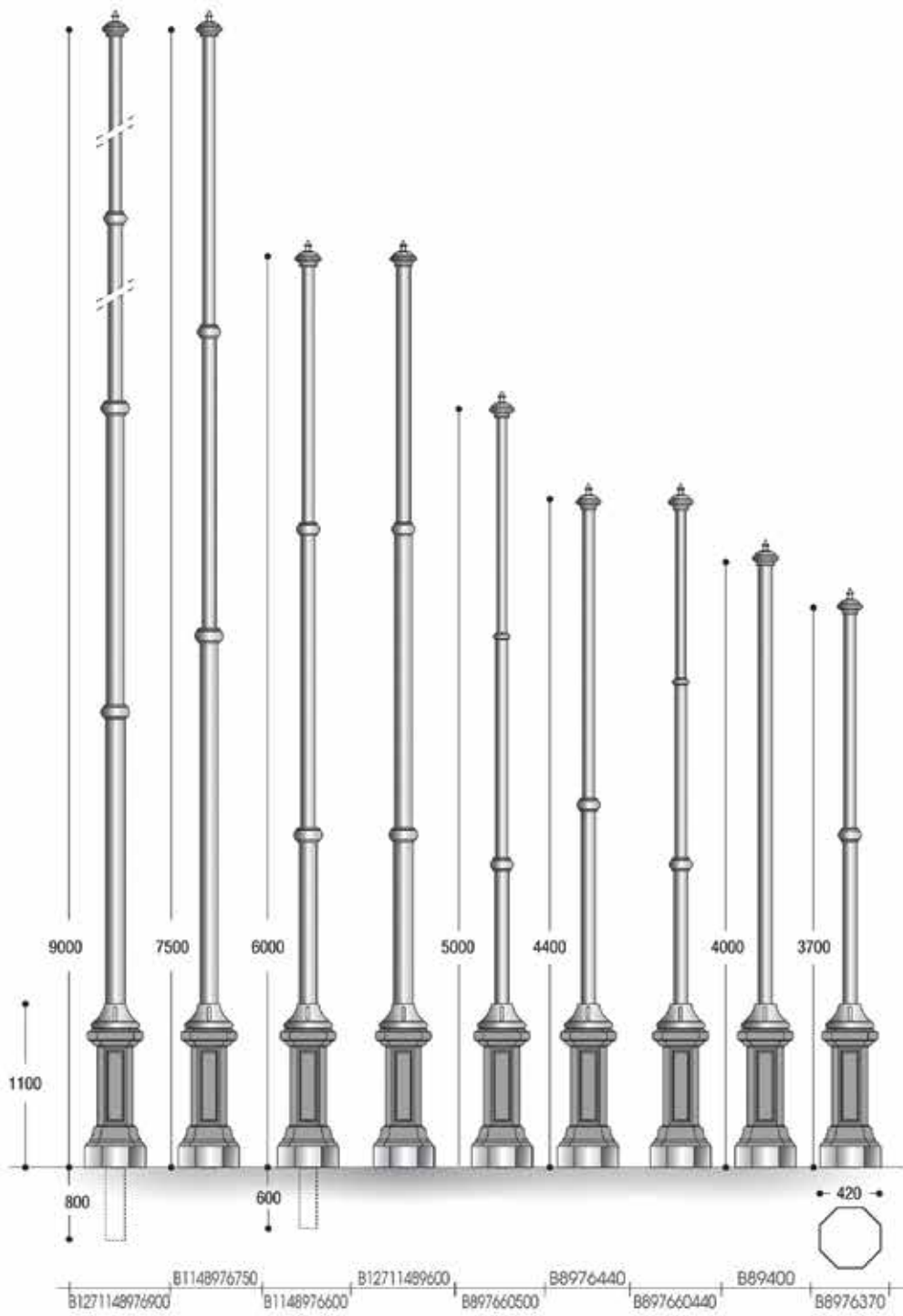





lainox 2 cut-off  
plainox 2



lazinc 4



goar/5/45



lainox 3 cut-off



goccia/9



gorp/6/45



lazinc 4 cut-off  
lazinc 4 cut-off zero



gla/1/40



lama/2



lial 5 cut-off



goa/10/35



lama/8



laott 6 cut-off  
laott 6 cut-off zero



goa/3/45



lamgoa/11



lainox 1



goap/7/45



lam/12



lainox 2



goap/15



glc/40/50  
glc/40/50 con duomo  
grx/40/50



lazinc 3



gor/4/45



goc/36/45







BALDAN  
BEAUTYFARM →  
LOCANDA SANT'AGNESE →  
RISTORANTE ROSA BLU →  
CENTRO SPORTIVO  
LE DUNE →  
BED AND BREAKFAST  
"J. Gelsomini" →  
Farmacia  
del Guili →  
Meroni →  
LA BARRICATA  
RISTORANTE  
VILLI SAN MICHELE  
11.07.0141



*brackets for cast iron poles*

GLN 24 - 28 - 30 - 61  
GLN 24/D - 28/D - 30/D - 61/D



*brackets for cast iron and iron poles*

GLN 24 - 28 - 30



*brackets for cast iron and iron poles*

GLN 35 - 50 - 51  
GLN 54 - 53 - 55



*brackets for cast iron poles*

GLN 31/D - 29/D  
GLN 33/D - 32/D



*brackets for cast iron and iron poles*

GLN 31 - 29  
GLN 33 - 32



*brackets for cast iron poles*

GLN 34 - 34/D



*brackets for cast iron and iron poles*

GLN 34



*brackets for cast iron and iron poles*

GLN 36



*wall mounted brackets in steel*

LN 31 - 29 - 33  
LN 34 - 32 - 35  
LN 43 - 43/1  
LN 37 - 43/2 - 2001  
LN 50 - 50/1 - 54  
LN 53 - 53/1 - 55  
LN 51 - 51/1



*wall mounted brackets in cast iron*

LN 42 - 41 - 40  
LN 15 - 85 - 17  
LN 61 - 60 - 30  
LN 27 - 28 - 24



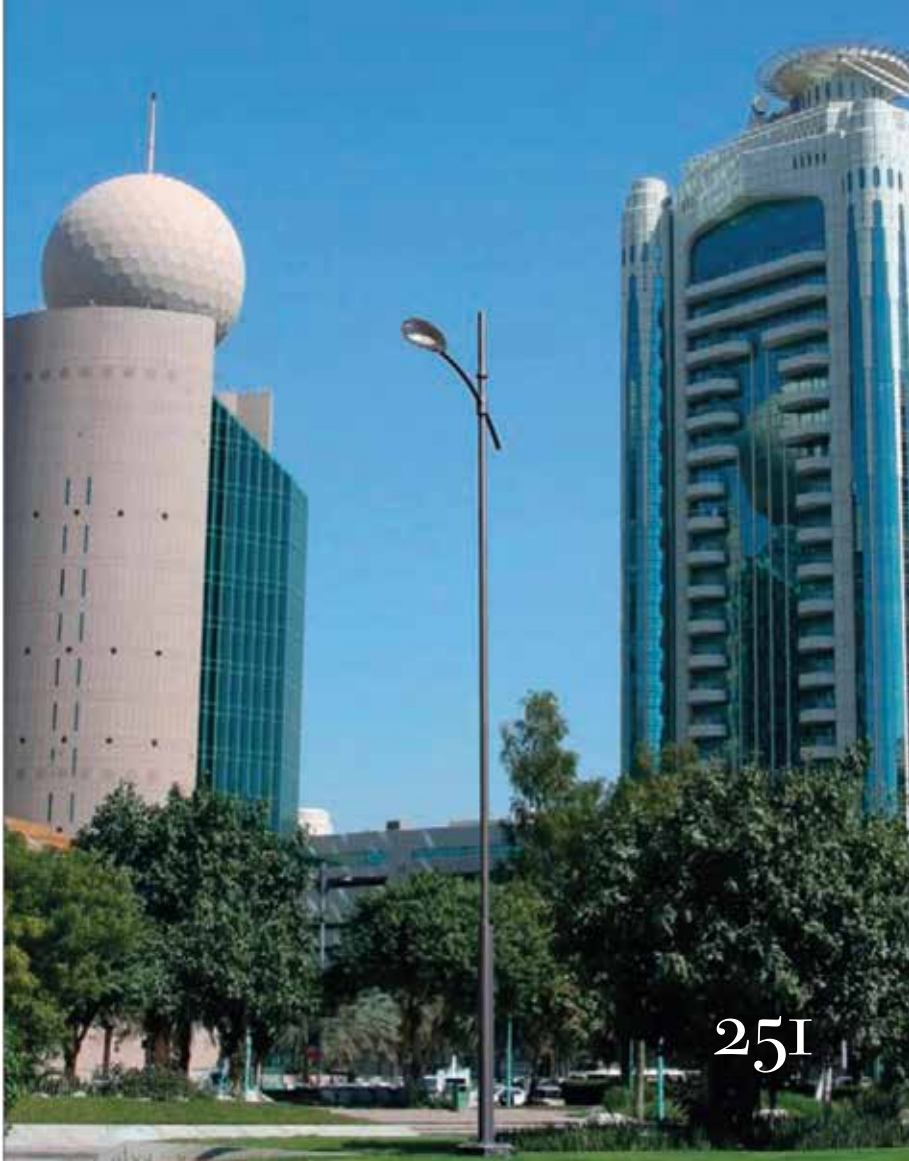





italian design  
Street Furniture





panchine  
benches



Lybra



Polis



Contrariè



Verona



Reverse



Helga

cestini  
litter bins



Aster



Aster wall



Blind



Viterbo



Giubileo



Vienna



Gamma



2004

dissuasori  
bollards



110



Cagliari e  
Tellaro



Polis



Portici



REH



102

griglie per alberi  
tree grids



Composè



Raffaello



Caravaggio



Canova



Bernini



Italia



City



Futura



2003



Kappa



Simple



Voilà



Elly



City



Verona



Trieste



Liberty



Portici



Prato



Cone



Catanzaro



Rapallo



Alassio



Victory



105



118



107



Brunelleschi



Modigliani



Michelangelo1

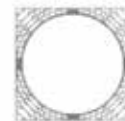

Michelangelo2



Botticelli

fontane  
fountains



Giò



Alex



Egea

fioriere  
planters



Tonda



Portici



Simy



Genova



Marty

portacicli  
cycle racks



2001



2002



City



Boomerang

paline  
sign posts



Sabry



Viterbo



Moderna

standardi-orologi  
banners-clocks



Ergo



Visual



2004



Orologio  
Totem



Orologio  
Liberty

transenne  
publicity barriers



Portici



Vienna



Lerici

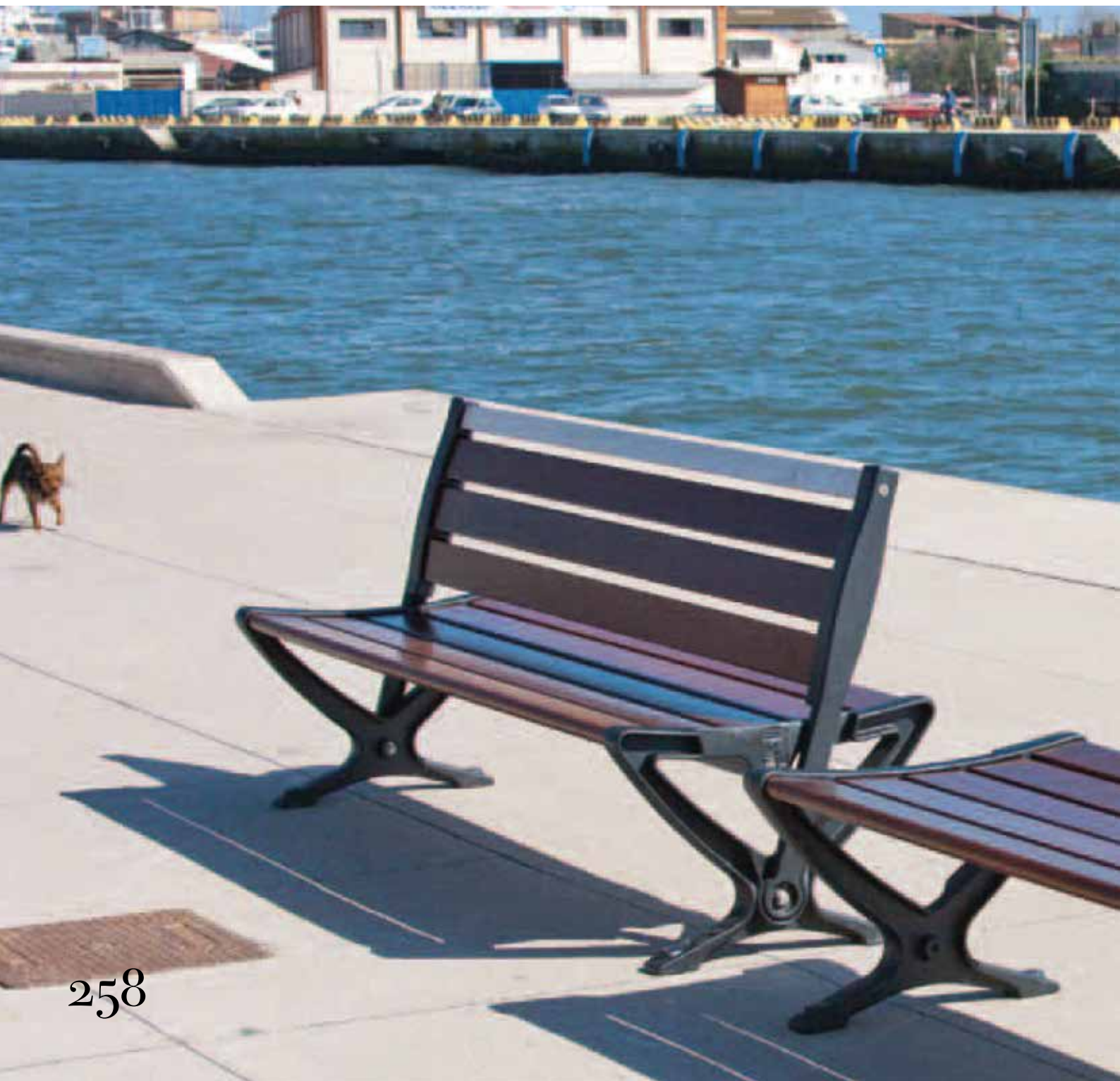

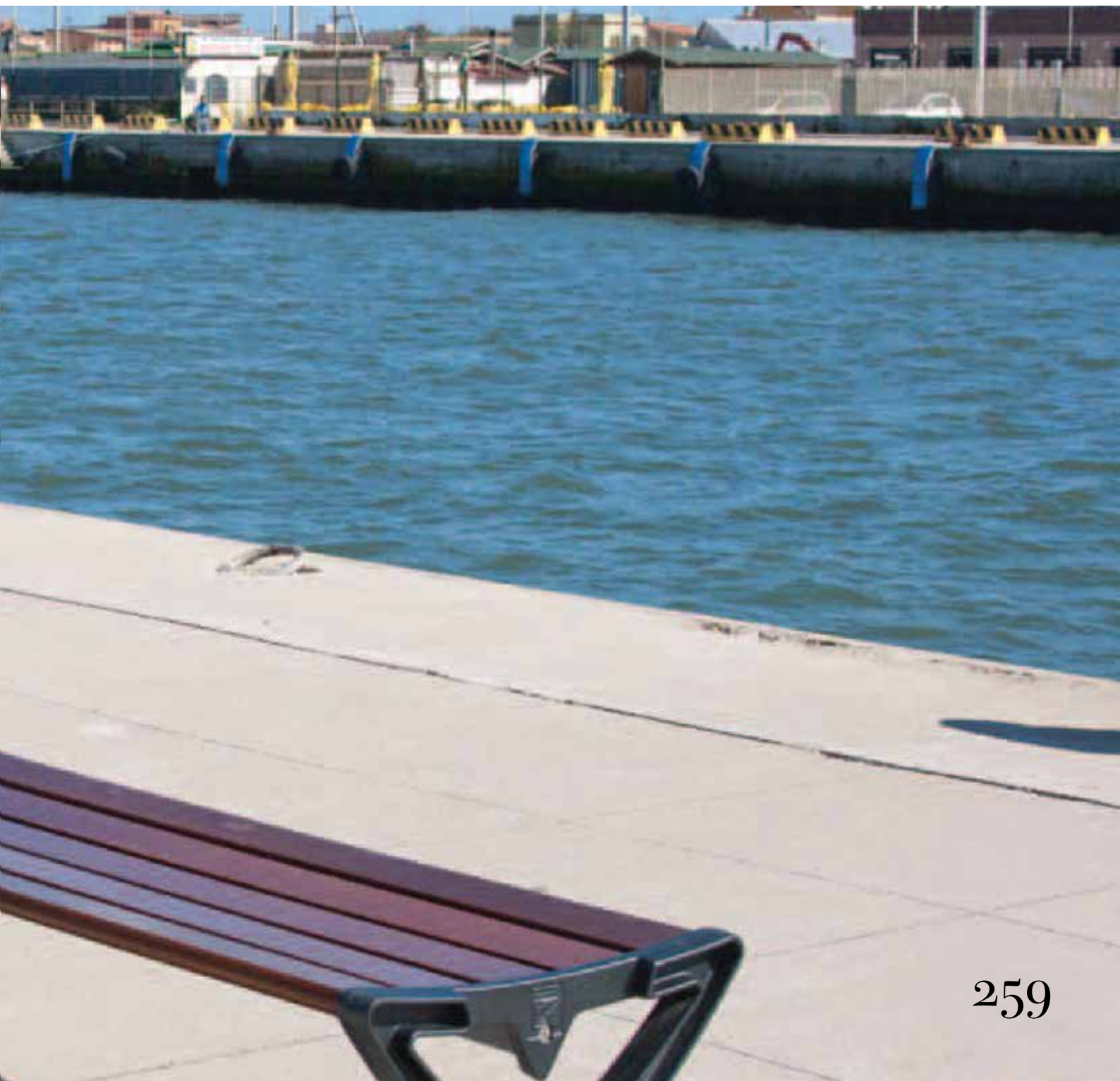

helga





italia

giò  
inox







tonda

simy



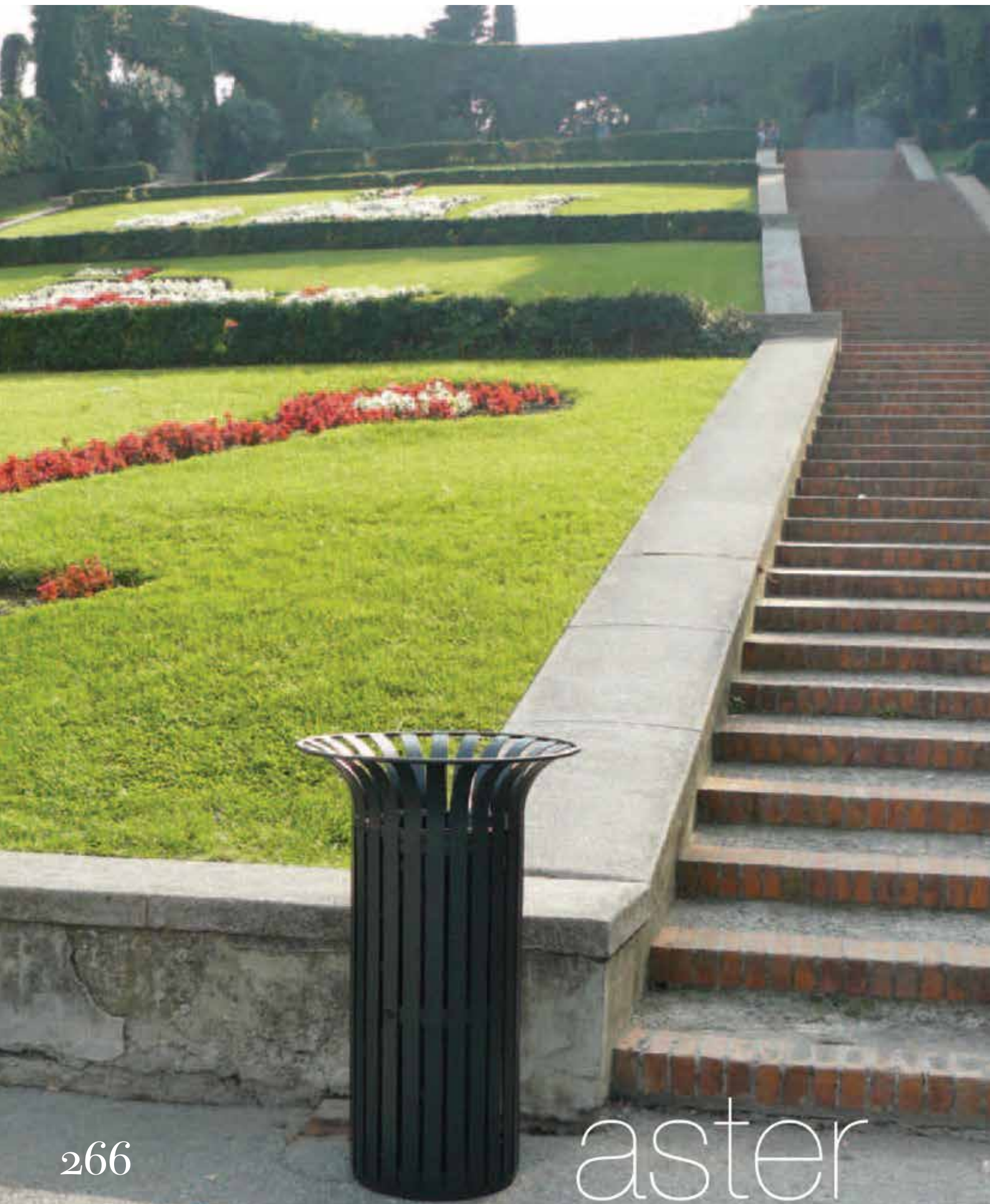



vienna

viterbo





liberty



VASCO DA GAMA

city



gamma





# rapallo



ergo

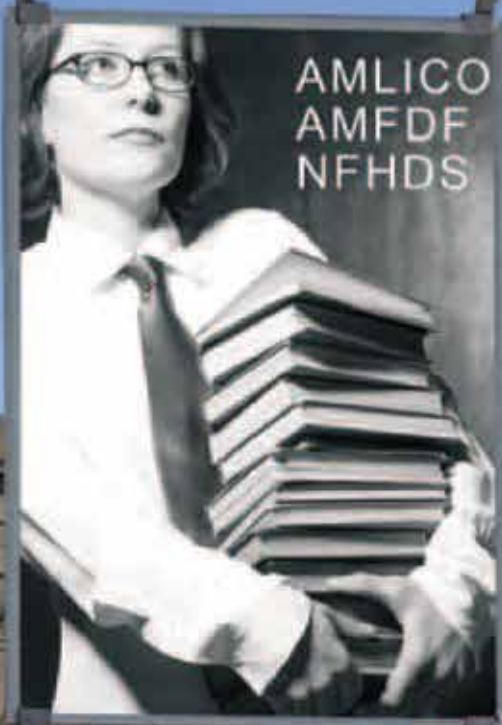

2004



# portici



liberty

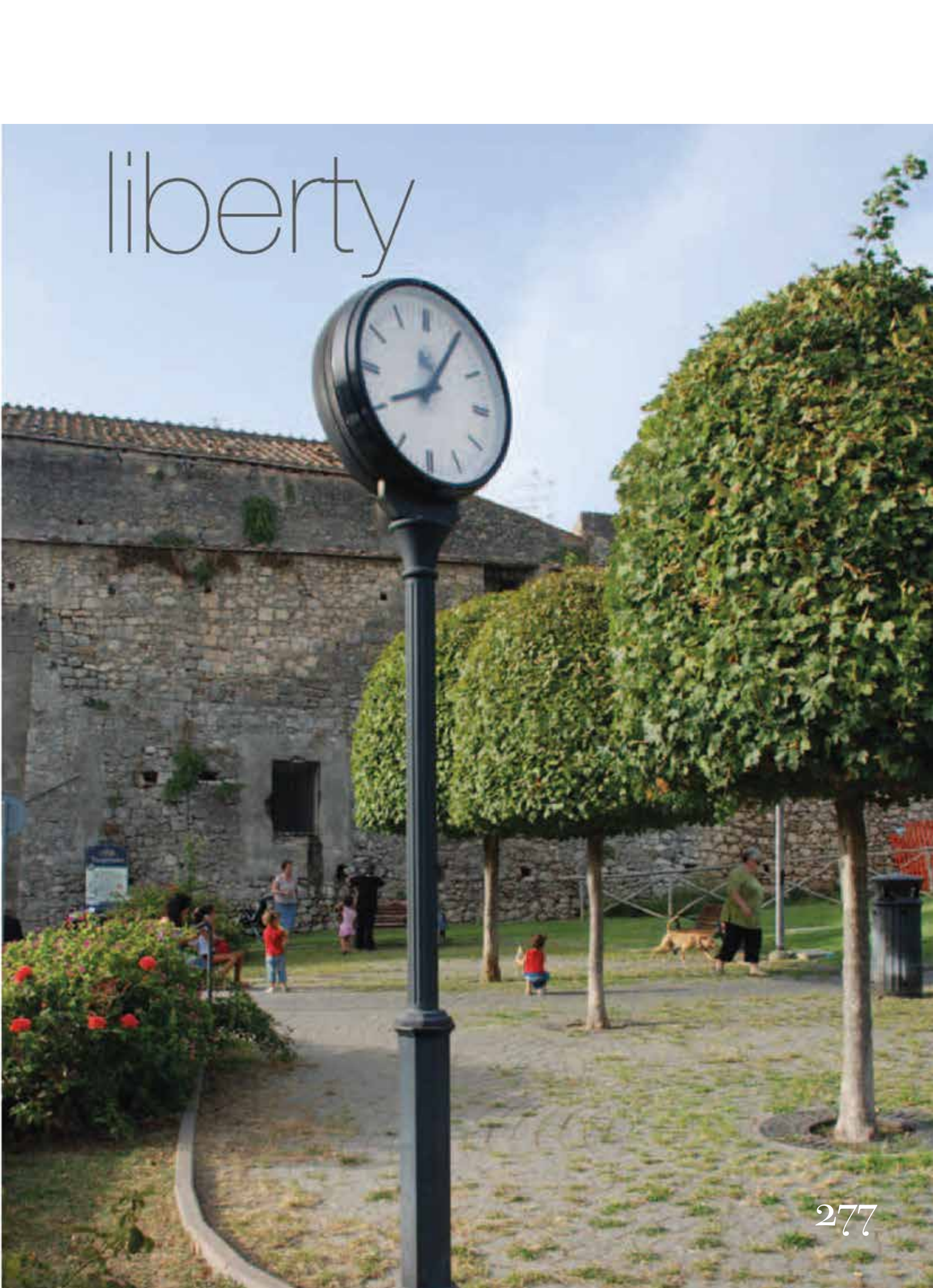

M A D E I N I T A L Y





ABU DHABI



THE NETHERLANDS









Al Khobar  
Saudi Arabia



Doha  
Qatar



Oman

286

Glasgow  
UK

London  
UK



Abu Dhabi  
UAE

THE NETHERLANDS



















ITALY







FRANCE





ITALY











304







www.ptmatic.com



Do not throw any waste  
in the toilet

ممنوع رمي القمامة في  
المرحاض



Toilet flushes  
automatically

يتم تصريف  
المرحاض تلقائيا



use me responsibly  
استخدمني بمسؤولية



M A D E I N I T A L Y



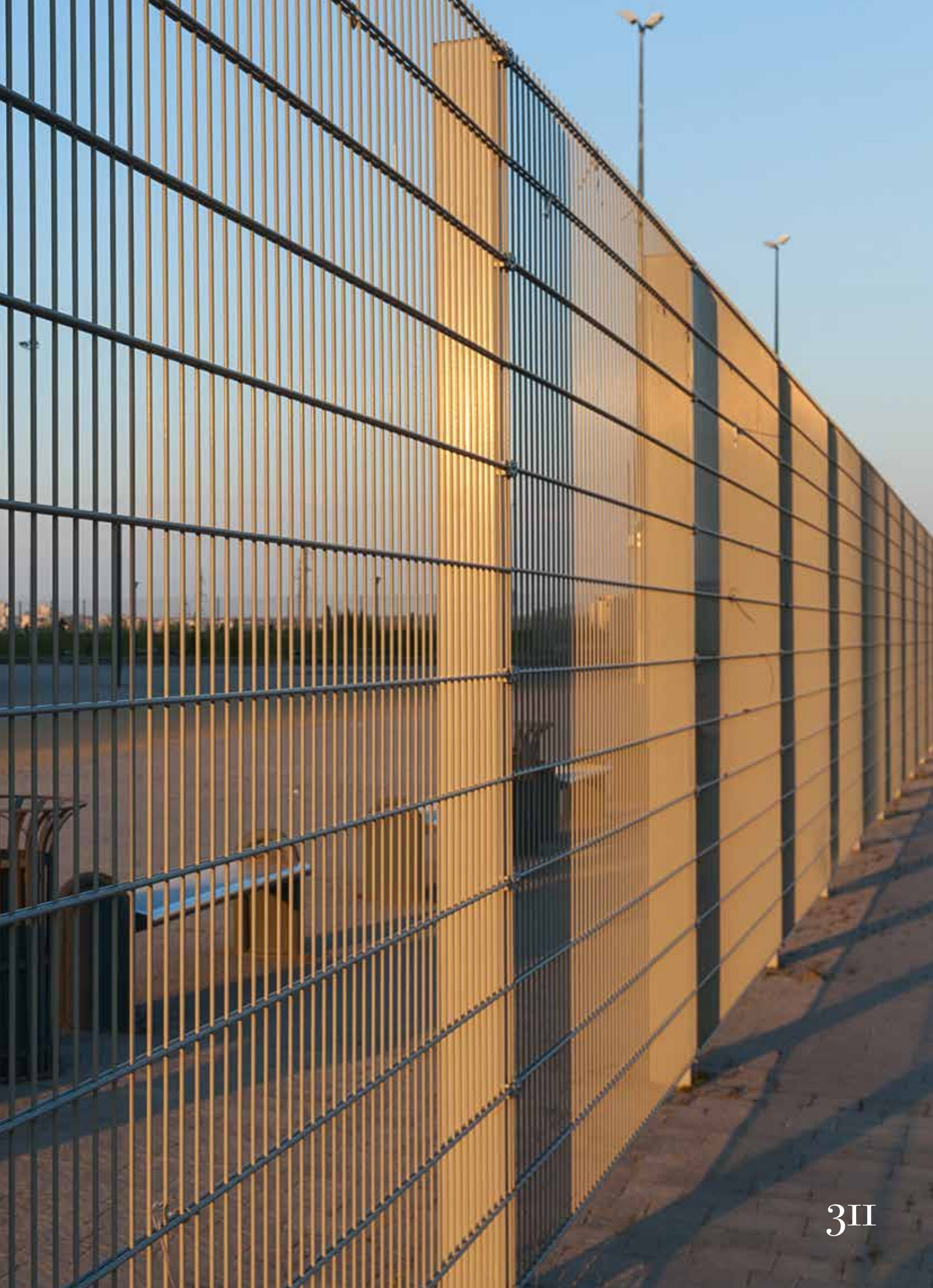



SECURITY FENCES









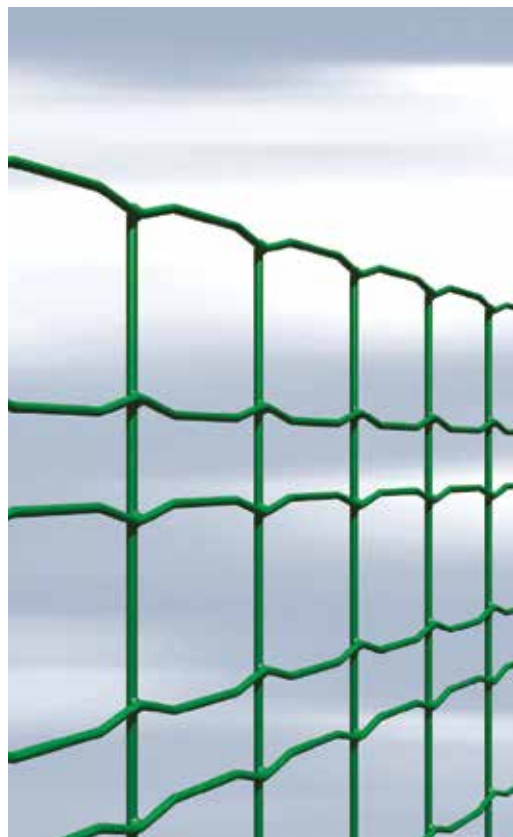
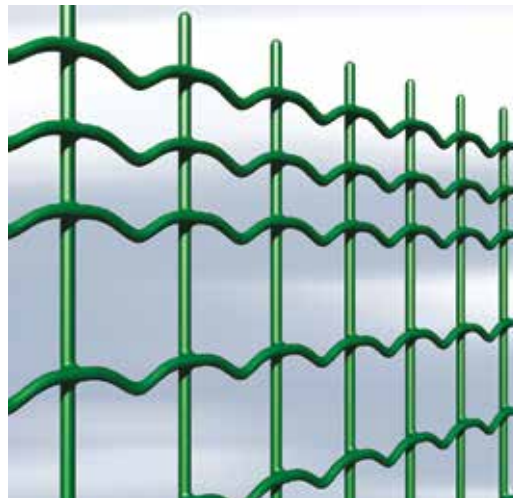



M A D E I N I T A L Y







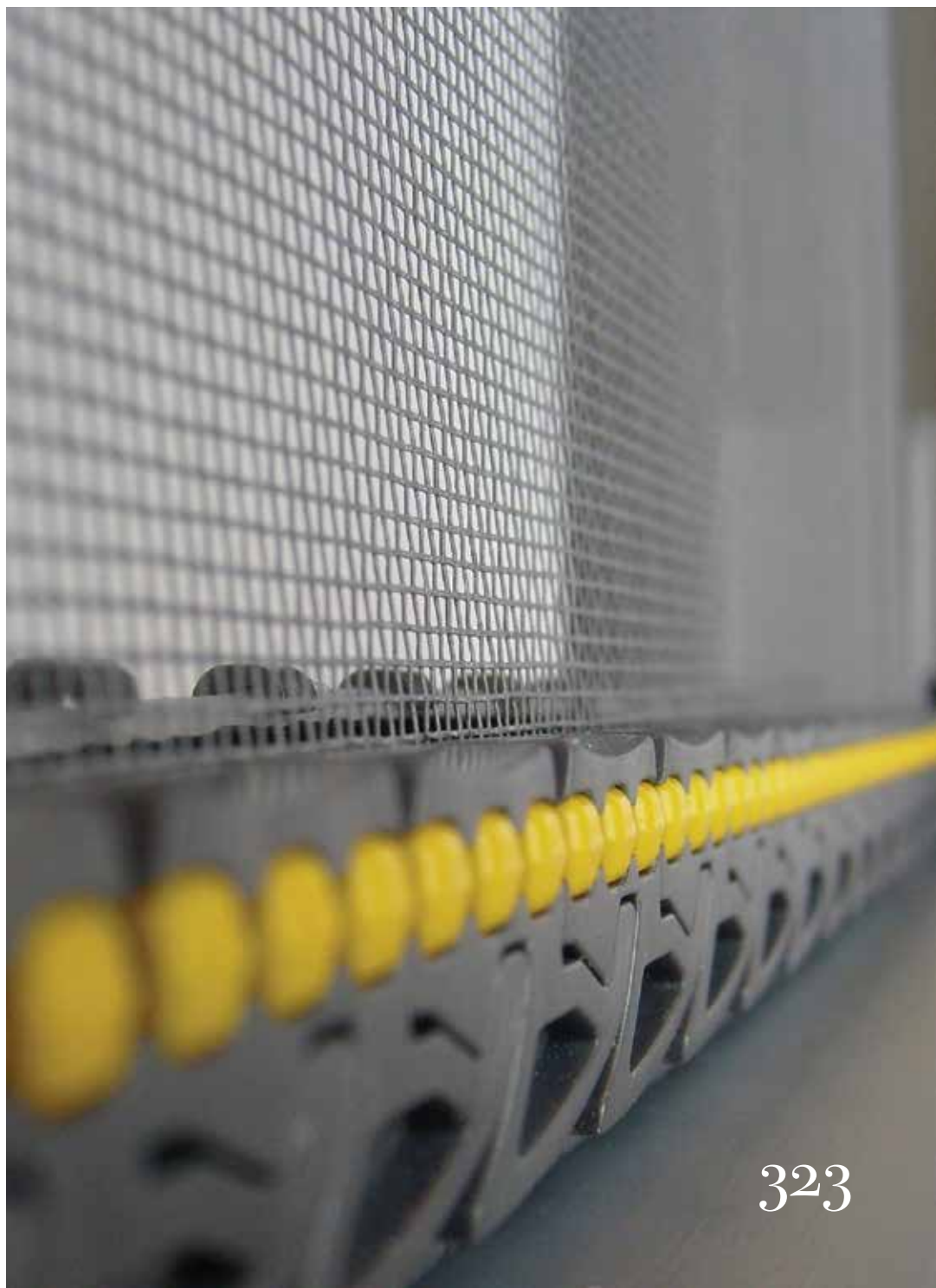







# ADRIATICO

---

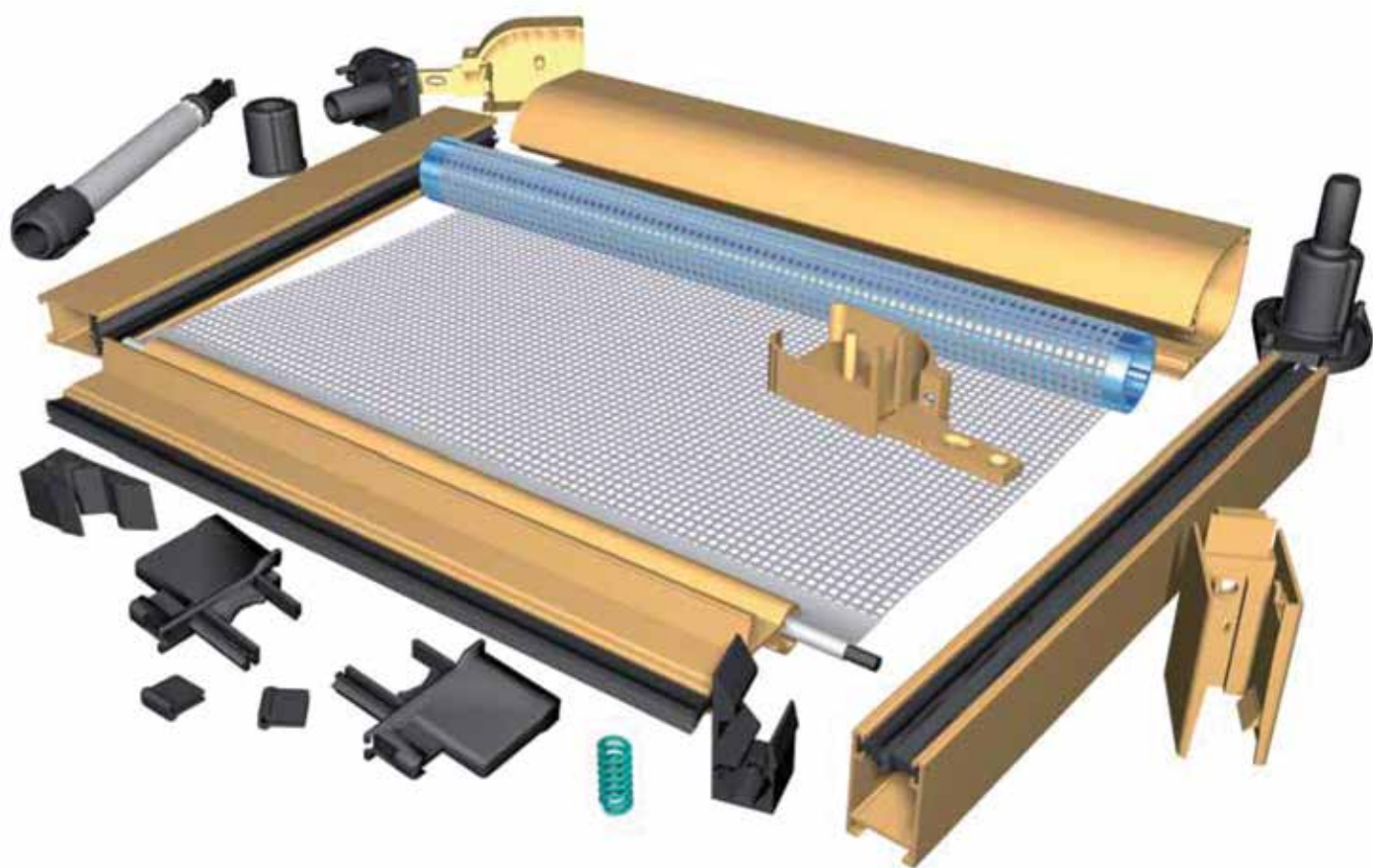



## SPRING OPERATED

Suggested for Windows and French doors



## FRONTAL INSTALLATION

Suggested for Windows and French doors



## LATERAL SLIDING

Suggested for French doors



## THE BRAKE

A brand new device has been added to the already rich range of possibilities that Adriatico Evolution allows. Thanks to the slow and gradual retraction allowed by this element, the pull bar can be easily unlocked at any time feeling an automatic and soft open-and-close movement.



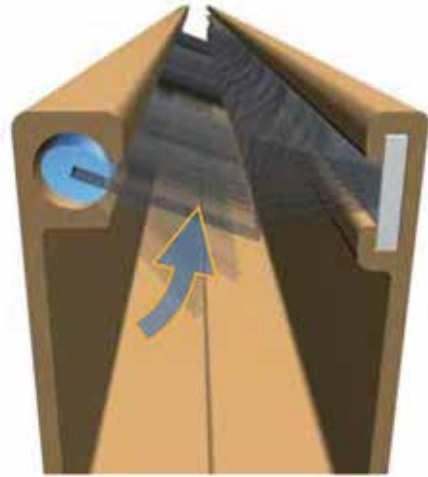

## ANTI-WIND BRUSH

A worldwide known international patent. The system is based on a special extruded profile where a circle groove is arranged for a particular thick and long brush. In presence of a strong wind the brush turns within the groove because the piles and lift and trapped by the mesh which remains locked in the guide without ejecting.

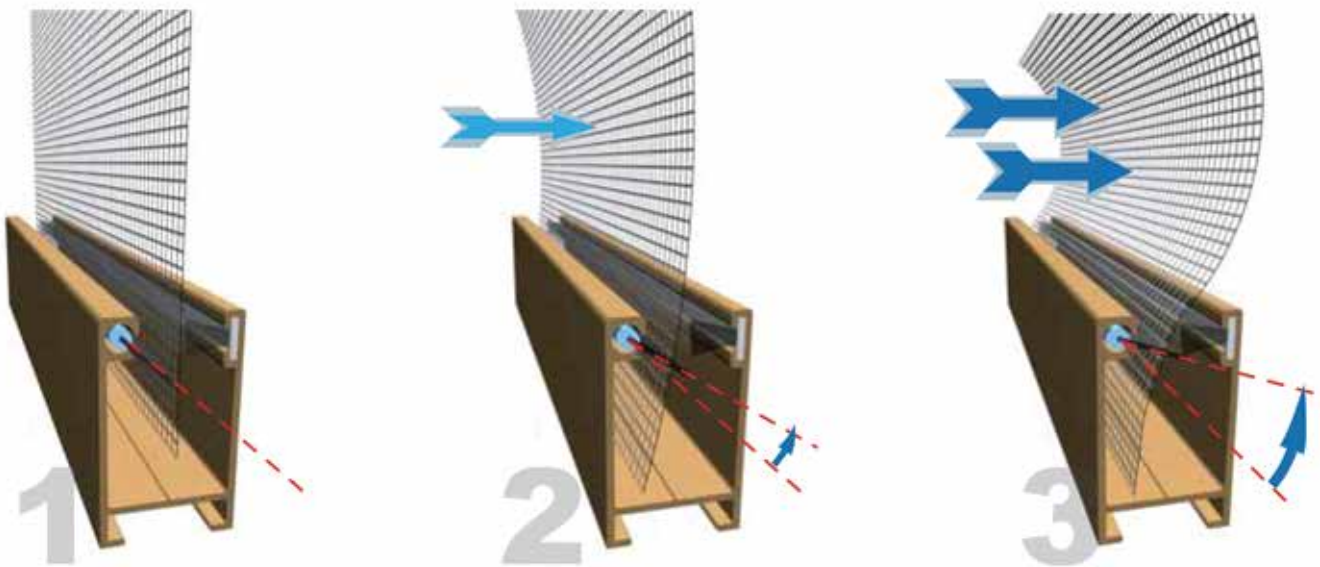





M A D E I N I T A L Y







# ADDRESS HOTEL - BURJ KHALIFA

---



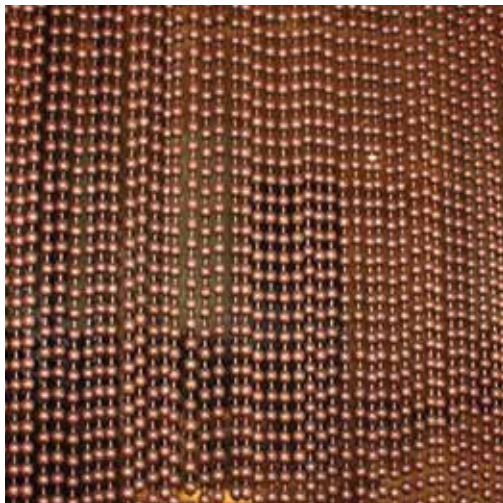

# BURJ KHALIFA - MEDICAL CENTER

---





# LE REVE - PRIVATE APARTMENT





## FAIRMONT ABU DHABI - BAB EL BAHR

---







# INTERCONTINENTAL - CROWN PLAZA





# INTERCONTINENTAL HOTEL DIFC - DUBAI



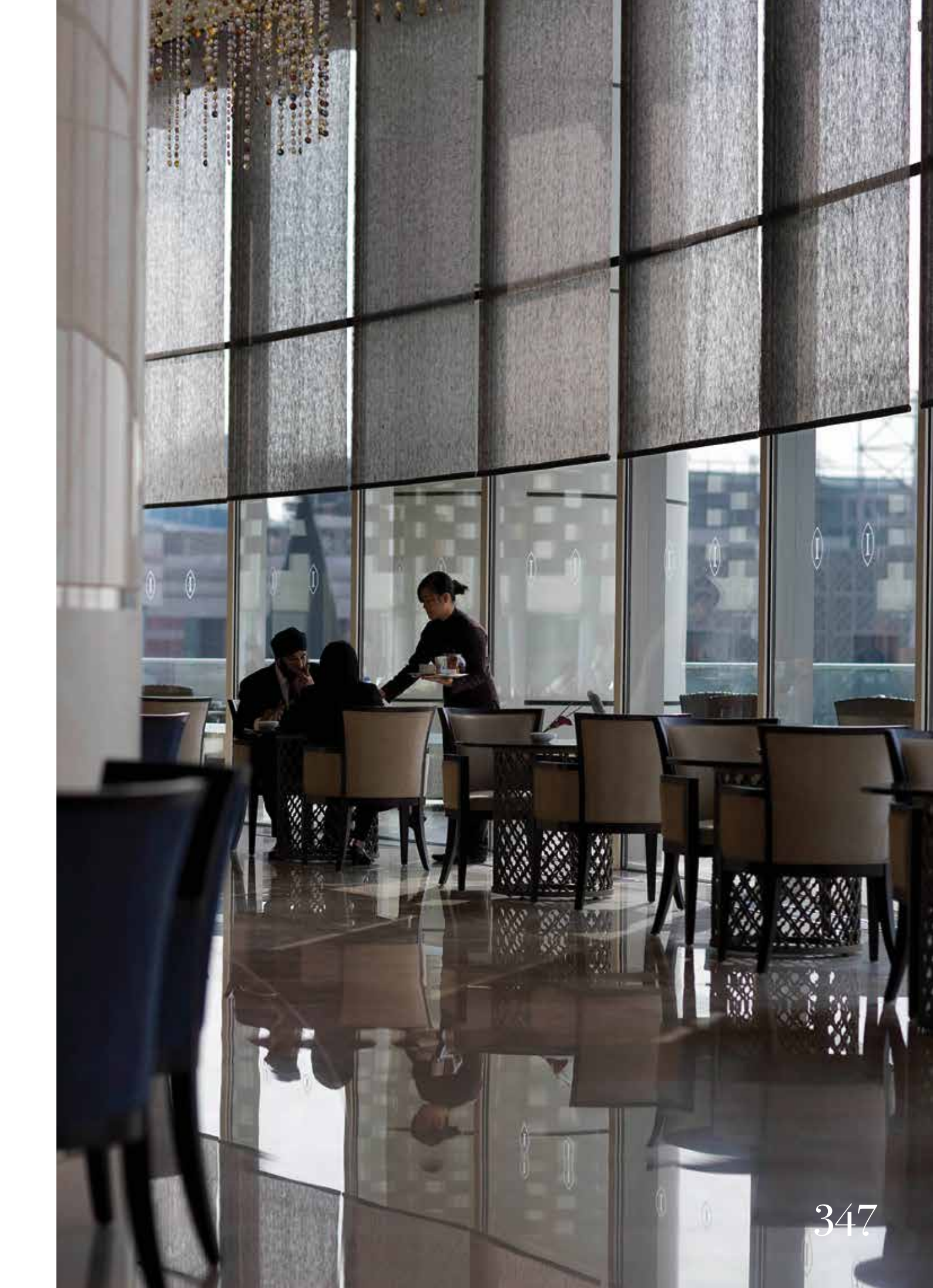

## AWNINGS

---





M A D E I N I T A L Y





















Arjaan Business Tower • 8th Floor • Office 805  
P.O. BOX 502396 • Dubai Media City • United Arab Emirates

Tel +971.4.434.7172 • Fax +971.4.434.3040  
info@xportemirates.com • www.xportemirates.com

The Company reserves the right to amend all products herein detailed, any time and without prior notice.

Printed in UAE July 2015